

TRAFFIC IMPACT ANALYSIS

FAIRWAY ESTATES
Traffic Impact Analysis

FLORENCE, OREGON

May 6, 2022

160 Madison Street, Suite A
Eugene, Oregon 97402
541.513.3376

SANDOW
ENGINEERING

Traffic Impact Analysis

FAIRWAY ESTATES



RENEWAL 06/30/22

Florence, Oregon
May 6, 2022

Kelly Sandow PE

**SANDOW
ENGINEERING**
160 Madison Street, Suite A
Eugene Oregon 97402
541.513.3376
sandowengineering.com
project # 5924

EXECUTIVE SUMMARY

This report provides the Traffic Impact Analysis and findings prepared for phase 2 of Fairway Estates Subdivision in Florence, Oregon. The subject site is located at tax lot 1500 of Assessor's Map 18-12-15.

Fairway Estates phase 2 expands the existing subdivision to the north and includes 42 single family lots. Access to the site will be from Rhododendron Drive via Tournament Dr.

The analysis evaluates the transportation impacts per the City of Florence criteria, evaluating adjacent roadway and intersection operations.

FINDINGS

The following report recommendations are based on the information and analysis documented in this report.

- The addition of development trips does not trigger intersection mitigation.
- The addition of development trips does not increase queuing conditions at the study area intersections.
- The site accesses will operate safely and efficiently for all modes of travel.
- The site will have safe and adequate access for pedestrians and bicycles to and within the site.

CONTENTS

1.0	BACKGROUND	4
1.1	SITE INFORMATION	4
1.2	DEVELOPMENT PROPOSAL.....	4
1.3	ANALYSIS SCOPE.....	4
	FIGURE 1- VICINITY MAP AND SITE LOCATION	5
2.0	EXISTING ROADWAY CONDITIONS	6
2.1	STREET NETWORK	6
	TABLE 1: ROADWAY CHARACTERISTICS WITHIN STUDY AREA	6
2.2	STUDY INTERSECTIONS.....	6
2.3	CRASH ANALYSIS	6
	TABLE 2: INTERSECTION CRASH RATES.....	7
	FIGURE 2- LANE CONFIGURATION AND TRAFFIC CONTROL	8
3.0	DEVELOPMENT TRIP GENERATION AND DISTRIBUTION	9
3.1	DEVELOPMENT TRIP GENERATION	9
	TABLE 3: PEAK HOUR TRIP GENERATION	9
3.2	DEVELOPMENT TRIP DISTRIBUTION.....	9
	FIGURE 3: AM PEAK HOUR DEVELOPMENT TRIPS	10
	FIGURE 4: PM PEAK HOUR DEVELOPMENT TRIPS.....	11
4.0	BACKGROUND TRAFFIC VOLUMES	12
4.1	INTERSECTION COUNTS	12
4.2	ADJUSTMENTS.....	12
4.3	FUTURE YEAR BACKGROUND VOLUMES.....	13
4.4	FINAL TRAFFIC VOLUMES	13
	FIGURE 5: YEAR 2022 AM BACKGROUND TRAFFIC VOLUMES	14
	FIGURE 6: YEAR 2022 PM BACKGROUND TRAFFIC VOLUMES	15
	FIGURE 7: YEAR 2024 AM PEAK HOUR TRAFFIC VOLUMES.....	16
	FIGURE 8: YEAR 2024 PM PEAK HOUR TRAFFIC VOLUMES.....	17
	FIGURE 9: YEAR 2029 AM PEAK HOUR TRAFFIC VOLUMES.....	18
	FIGURE 10: YEAR 2029 PM PEAK HOUR TRAFFIC VOLUMES.....	19
5.0	INTERSECTION ANALYSIS	20
5.1	PERFORMANCE MEASURES.....	20
	TABLE 4: HCM LEVEL OF SERVICE FOR INTERSECTIONS.....	20
5.2	INTERSECTION ANALYSIS RESULTS.....	21
	TABLE 5: INTERSECTION PERFORMANCE: WEEKDAY AM PEAK HOUR	21
	TABLE 6: INTERSECTION PERFORMANCE: WEEKDAY PM PEAK HOUR	21
5.3	QUEUE ANALYSIS.....	21
	TABLE 8: INTERSECTION QUEUING: WEEKDAY AM PEAK HOUR	22
	TABLE 9: INTERSECTION QUEUING: WEEKDAY PM PEAK HOUR.....	22

6.0 CONCLUSION.....22

LIST OF APPENDICES

APPENDIX A: SITE PLAN

APPENDIX B: CRASH DATA

APPENDIX C: TRAFFIC VOLUMES

APPENDIX D: SYNCHRO OUTPUTS

APPENDIX E: QUEUING OUTPUTS

1.0 BACKGROUND

1.1 SITE INFORMATION

This report provides the Traffic Impact Analysis and findings prepared for a phase 2 of Fairway Estates subdivision in Florence, Oregon. The subject site is located at 4000 Rhododendron Drive and is located at Tax Lot 1500 of Assessor's Map 18-12-15. The site is currently vacant.

Figure 1 contains the site location and vicinity map.

1.2 DEVELOPMENT PROPOSAL

The proposal is to expand the existing subdivision to the north and to construct 42 single family lots. The development includes the extension of Caddington Ln and Dunbar Way, into the site.

Access to the site will be from Rhododendron Dr via Tournament Dr.

1.3 ANALYSIS SCOPE

As per City of Florence code FCC 10-1—1-4-E(2)(c), a TIA is required if the development includes 25 or more single family dwellings or will increase the ADT by 250. The site meets the criteria for requiring a Traffic Impact Analysis.

The analysis includes:

- Evaluation of site access point: Rhododendron at Tournament Dr
- Intersection evaluation: Rhododendron at Tournament Dr

The evaluation is prepared for the AM and Peak Period (7:00-9:00 AM) and the PM Peak Period (4:00-6:00 pm) for the following locations:

The analysis is performed for:

- Existing conditions, year 2022
- Estimated year of completion, year 2024, with and without the proposed development
- Five-year planning horizon year, year 2029, with and without the proposed development



Fairway Estates, Florence, OR

Figure 1: Site Location and Vicinity Map

2.0 EXISTING ROADWAY CONDITIONS

2.1 STREET NETWORK

Public streets included within the study area are Rhododendron Dr and 35th St. The roadway characteristics within the study area are included in Table 1.

TABLE 1: ROADWAY CHARACTERISTICS WITHIN STUDY AREA

Characteristic	Rhododendron Ln	35 th St
Jurisdiction	City	City
Classification	Minor Arterial	Collector
Lanes per Direction	1	1
Center Left-Turn Lane	No	No
Restrictions in the Median	None	None
Bike Lanes Present	No	Yes
Sidewalks Present	No	No
Transit Route	No	No
On-Street Parking	No	No

2.2 STUDY INTERSECTIONS

The following intersection are included in this study:

Two-Way Stop Controlled

- Rhododendron Dr @ Tournament Dr
- Rhododendron Dr @ 35th St

Figure 2 illustrates the study area intersection geometry and control.

2.3 CRASH ANALYSIS

A crash evaluation was performed for the study area intersections. The analysis investigates crash data available for the most recent 5 years, 1/1/2016-12/31/2020, to determine a crash rate in crashes per million entering vehicles and the type of crashes that occurred. Year 2020 crash data has not been provided for use. The crash analysis follows the HCM Critical Crash Rate methodology. The calculated intersection crash rates are compared to the critical crash rate. If the calculated crash rate exceeds the critical crash rate, the location is considered for further mitigation measures. Crash data was provided by ODOT for the study area and is included in Appendix B. The results of the crash analysis are provided in Table 2.

TABLE 2: INTERSECTION CRASH RATES

Location	Intersection Type	Number of Crashes	ADT	MEV	Crash Rate	Critical Crash Rate	
Rhododendron at Tournament	Stop	0	4600	0	0.00	0.00	Under
Rhododendron at 35 th	Stop	0	3510	0	0.00	0.00	Under

*(crashes/million entering vehicles)

As illustrated within Table 2, there were no reported crashes at the study area intersections for the past 5 years. Therefore, mitigation for crash history is not triggered by this development.

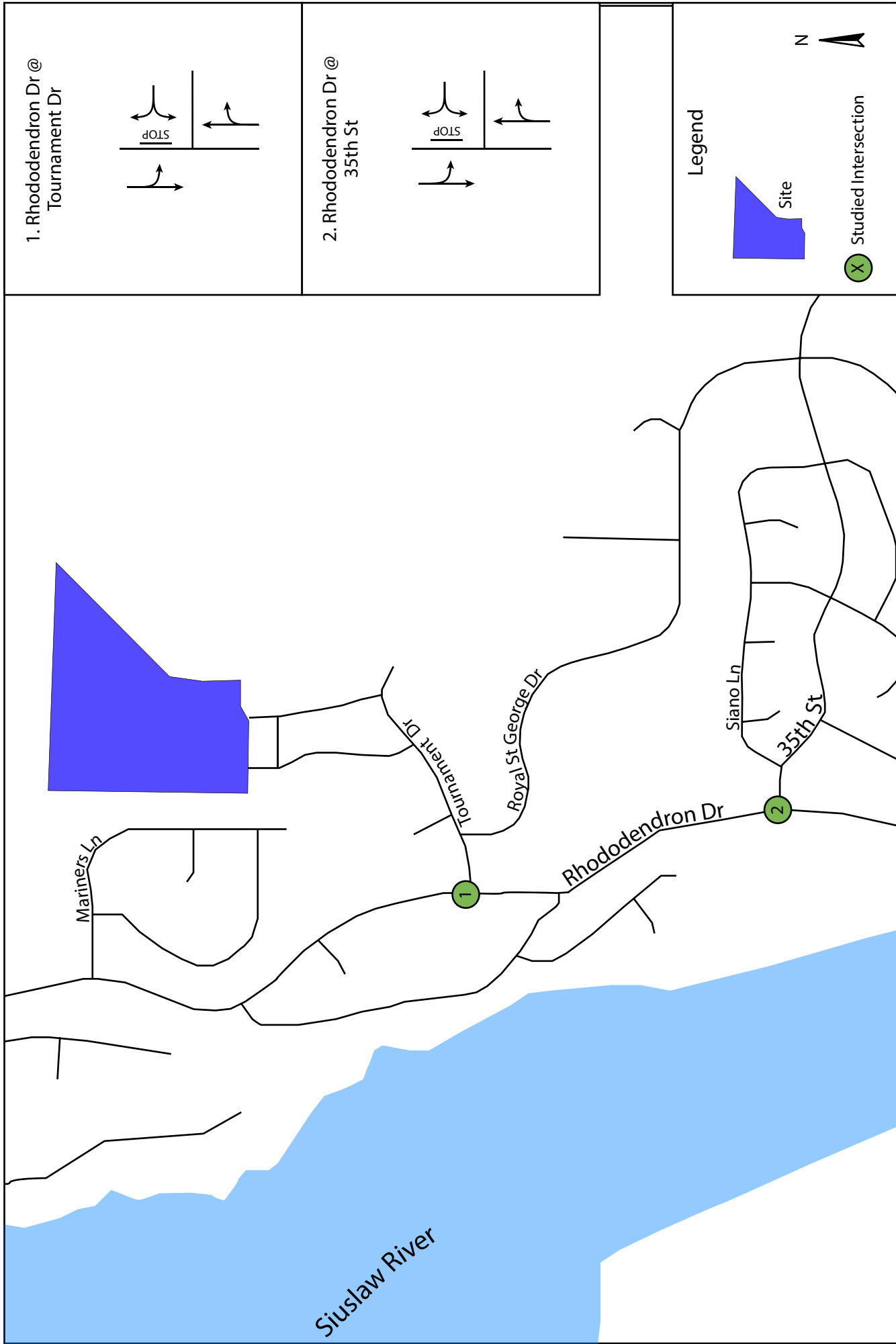

Figure 2: Lane Configuration and Traffic Control

Fairway Estates, Florence, OR

3.0 DEVELOPMENT TRIP GENERATION AND DISTRIBUTION

3.1 DEVELOPMENT TRIP GENERATION

The PM peak hour trips generated by the site are estimated using the ITE Trip Generation Manual 11th Edition. Table 3 provides the trip generation estimate for the AM and PM Peak Hours. The land use that most closely matches the proposed use is 210- Single Family Residential.

TABLE 3: PEAK HOUR TRIP GENERATION

Land Use Code	Size (units)	Rate	Trips	IN	Out
AM					
210- Single Family	42	$\ln(t)=0.91\ln(x)+0.12$	34	(26%) 9	(74%) 25
PM					
210- Single Family	42	$\ln(t)=0.94\ln(x)+0.27$	44	(63%) 28	(37%) 16

3.2 DEVELOPMENT TRIP DISTRIBUTION

The existing travel patterns from the traffic counts are used to estimate how the development trips will use the surrounding transportation system to access the site with modifications for reasonable origins and destinations. The trip origins/destinations are assumed at:

- North on Rhododendron= 5%
- South on Rhododendron= 48%
- East on 35th= 47%

Figure 3 illustrates the development trip distribution for the AM Peak Hour and Figure 4 for the PM Peak Hour.

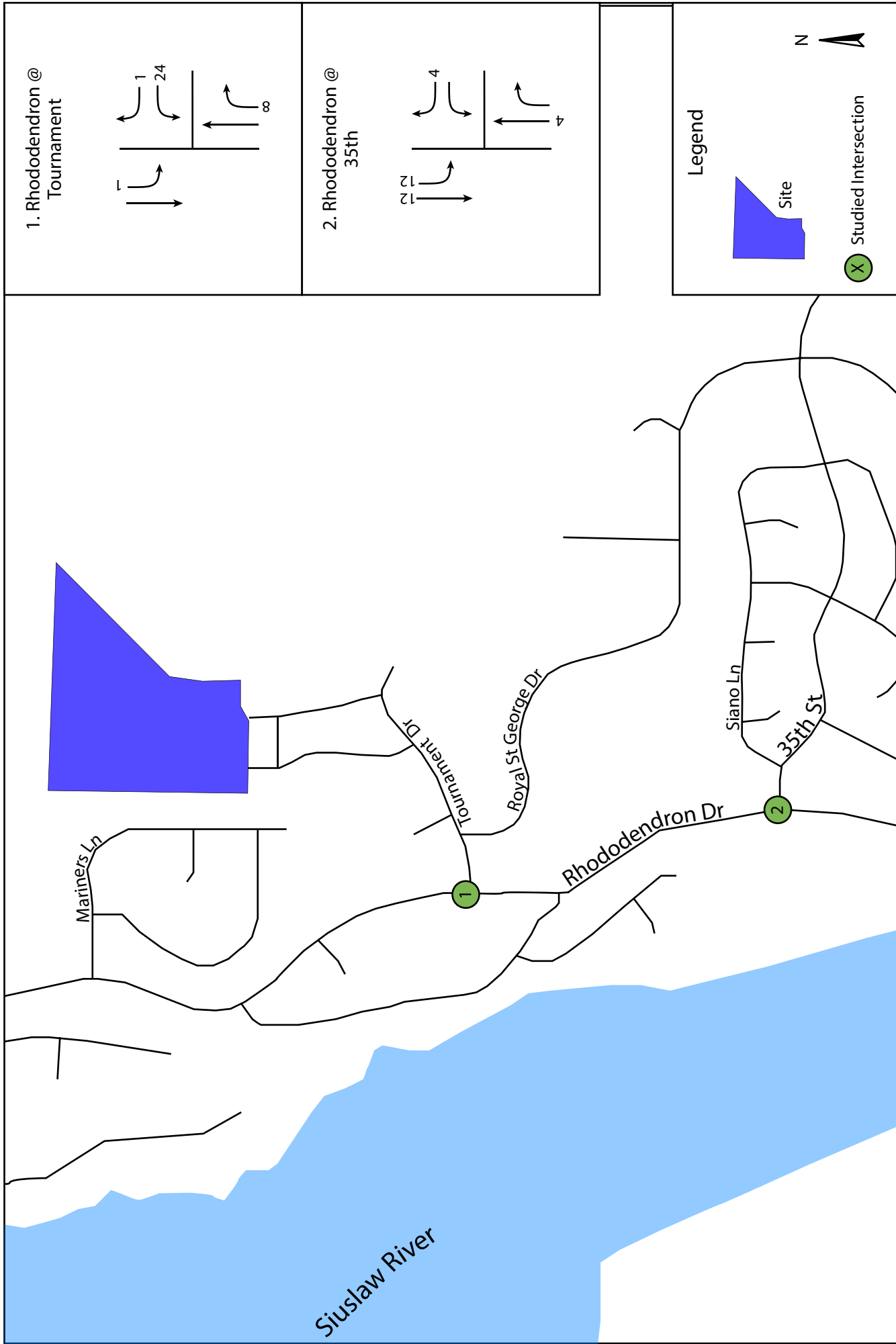

1. Rhododendron @
Tournament

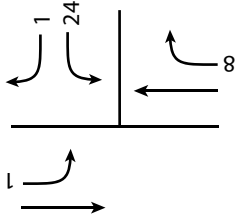

2. Rhododendron @
35th

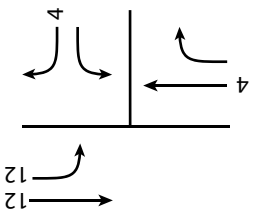

Legend

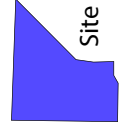

Site



Studied Intersection



N

Fairway Estates, Florence, OR

Figure 3: AM Peak Hour Development Trips

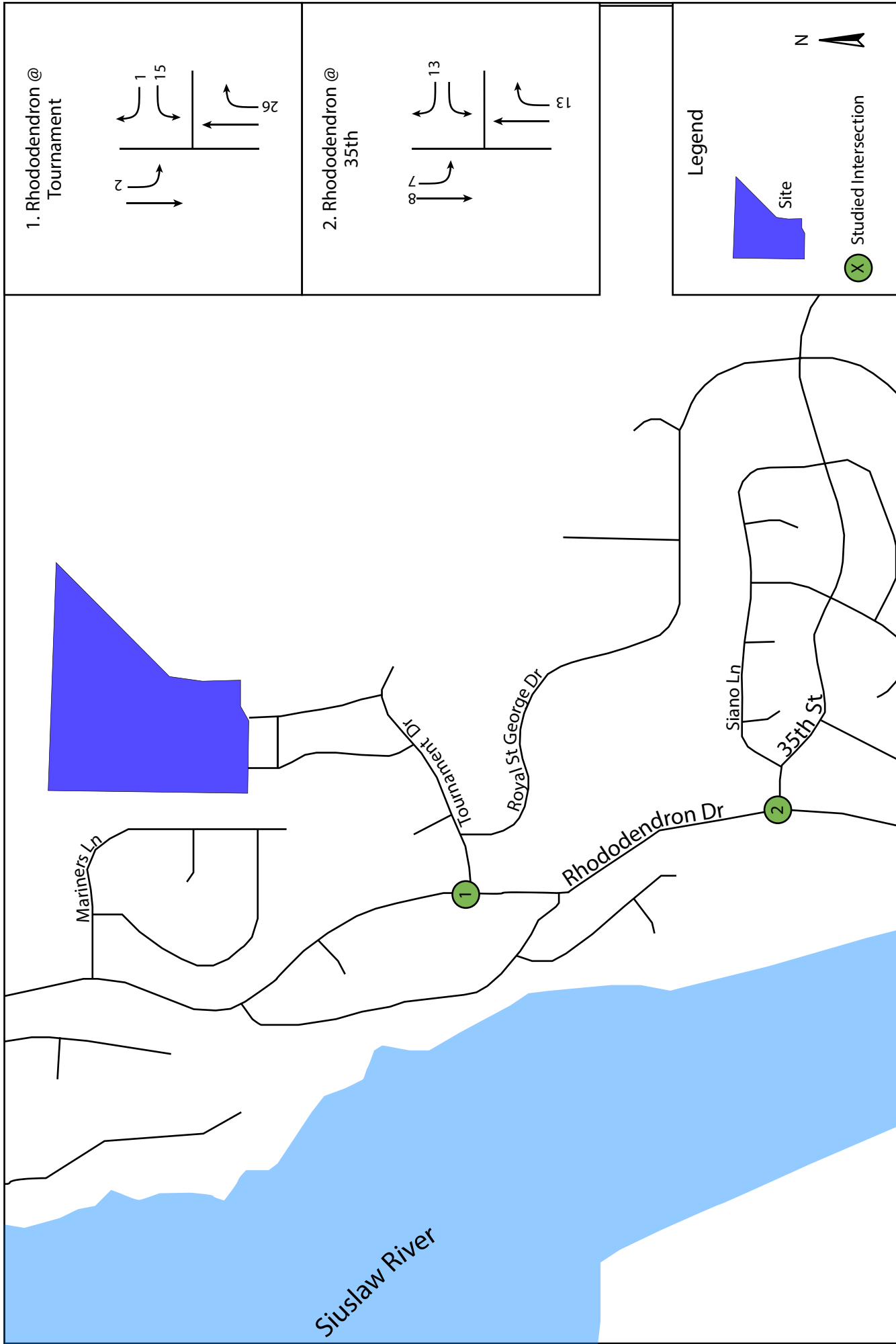

1. Rhododendron @
Tournament

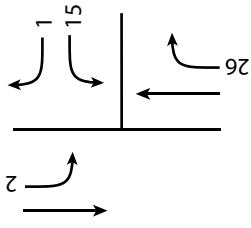

2. Rhododendron @
35th

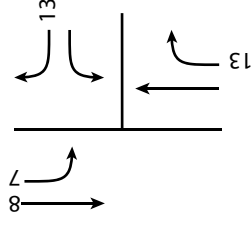

Legend

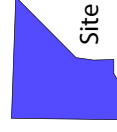

Site



Studied Intersection



N

Fairway Estates, Florence, OR

Figure 4: PM Peak Hour Development Trips

4.0 BACKGROUND TRAFFIC VOLUMES

4.1 INTERSECTION COUNTS

The Traffic Impact Analysis for the adjacent development to the south, collected AM and PM peak hour traffic volumes at the intersection of Rhododendron Dr at 35th St. The count for this intersection, provided in Kittleson's September 24, 2020 Memo, were taken on August 27, 2020. This data is provided in Appendix C.

Sandow Engineering collected the AM and PM peak hour counts at Rhododendron Dr at Tournament Dr. The counts were collected on October 20th and 21st 2021.

4.2 ADJUSTMENTS

Seasonal Adjustment

The application of seasonal adjustment factors account for the fact that volumes along State Highways and recreational routes tend to fluctuate from month to month due to changes in recreational behavior, etc. Monthly volume variations for routes with recreational traffic show much higher seasonal peaking than routes with predominantly intercity traffic. The roadways in Florence have a seasonal peak associated with summer recreational activities. ODOT has an Automatic Traffic Recorder (ATR) located on Highway 101 north of Florence. The data from that ATR (ATR 20-026) illustrates that the peak months for traffic are July and August

Sandow Engineering took the count at Rhododendron at Tournament Drive in October. The count at Rhododendron at 35th was taken in late August.

ODOT's Analysis Procedures Manual details the methodology for calculating the seasonal adjustment factor. The ATR Methodology, using the ATR data was deemed not appropriate for this project. The ATR Methodology should not be used when the daily traffic volumes at the ATR is more than 10% difference from the site area. The ATR has an AADT of 7,224. Highway 101 at 35th St has an AADT of 10,900. The study area AADT is 51% higher than the AADT at the ATR. This is due to the rural nature of the roadway at the ATR. The ATR is located north of Heceta Beach Road where Hwy 101 becomes more rural with limited access points. This means that traffic variations between the low and peak season will be greater at the ATR than near the project site. Due to these factors, strictly applying a factor associated with seasonal fluctuation from the ATR will overestimate traffic flow. The more appropriate method is to use ODOT's Seasonal Trend Table. Using Coastal Destination, the SAF applied to August counts is 1.246. The SAF is applied to the traffic volumes to reflect peak season conditions. The seasonal adjustment factor calculation is provided in Appendix C.

Covid Adjustments

Counts collected during 2020 are generally affected by the Covid-19 shutdowns. Therefore, counts from this time need to be adjusted to reflect conditions consistent with non-COVID-19 traffic volumes. ODOT has been monitoring the traffic volume fluctuations on state highways

and comparing the current volumes to pre Covid-19 volumes. Based on this data, the traffic volume outside of the Portland Metro area during August 2020 are lower than this time pre-Covid-19. Therefore, the factor of 1.016 was applied to the August 2020 counts to represent “non-COVID-19” volumes. The traffic volumes in October 2022 have returned to pre-Covid levels. No adjustment is needed.

In Progress Development

Florence Subdivision

To the south of the development site is a subdivision that has been approved but not completed. It is located at tax lots 700 and 3800 at the NE corner of Rhododendron and 35th. Therefore, the trips generated by this proposed development are added to the background traffic volumes.

Fawn Ridge

Fawn Ridge is located on Rhododendron Drive approximately 2 miles north of the development site. The development trips from this site area added to the background trips.

Sandpines Phase 1

A portion of Phase 1 of the Sandpines/Fairway Estates has been completed. Phase 1 is proposed at 40 lots, 18 lots have been completed. The trip generation for the remaining 22 lots was added as background traffic.

4.3 FUTURE YEAR BACKGROUND VOLUMES

The proposed site development is projected to be completed by the year 2024. Consistent with the traffic impact analysis criteria, the intersections were evaluated for the year of completion and 5-year planning horizon. To account for naturally occurring traffic increases between the count year and the future analysis year, an annual growth rate is applied. ODOT’s Future Volume tables illustrate a nominal growth rate. To be conservative a growth rate of 1% was used.

4.4 FINAL TRAFFIC VOLUMES

The existing traffic volumes were adjusted according to the methodology described above. Appendix C provides the traffic volume calculations. The development trips are added to the background traffic volumes to represent the build conditions. The traffic volumes are illustrated in the following figures:

- Figure 5- Year 2022 AM Peak Hour Background
- Figure 6- Year 2022 PM Peak Hour Background
- Figure 7- Year 2024 AM Peak Hour Traffic Volumes
- Figure 8- Year 2024 PM Peak Hour Traffic Volumes
- Figure 9- Year 2029 AM Peak Hour Traffic Volumes
- Figure 10- Year 2029 PM Peak Hour Traffic Volumes

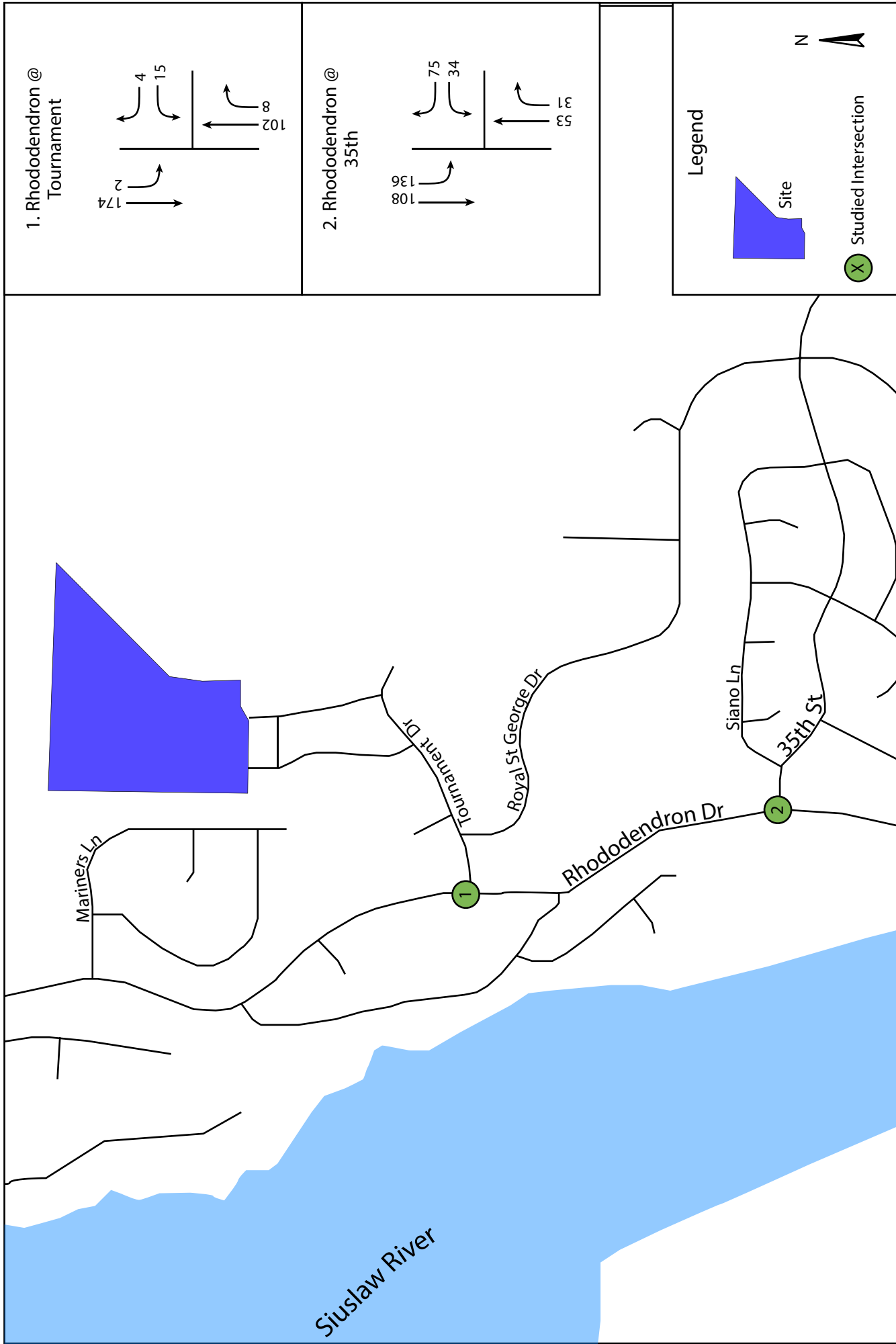

1. Rhododendron @ Tournament

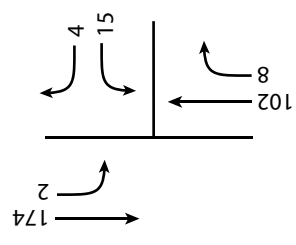

2. Rhododendron @ 35th

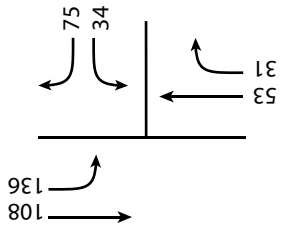

Legend

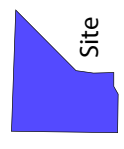

Fairway Estates, Florence, OR

Figure 5: Year 2022 AM Background Traffic Volumes

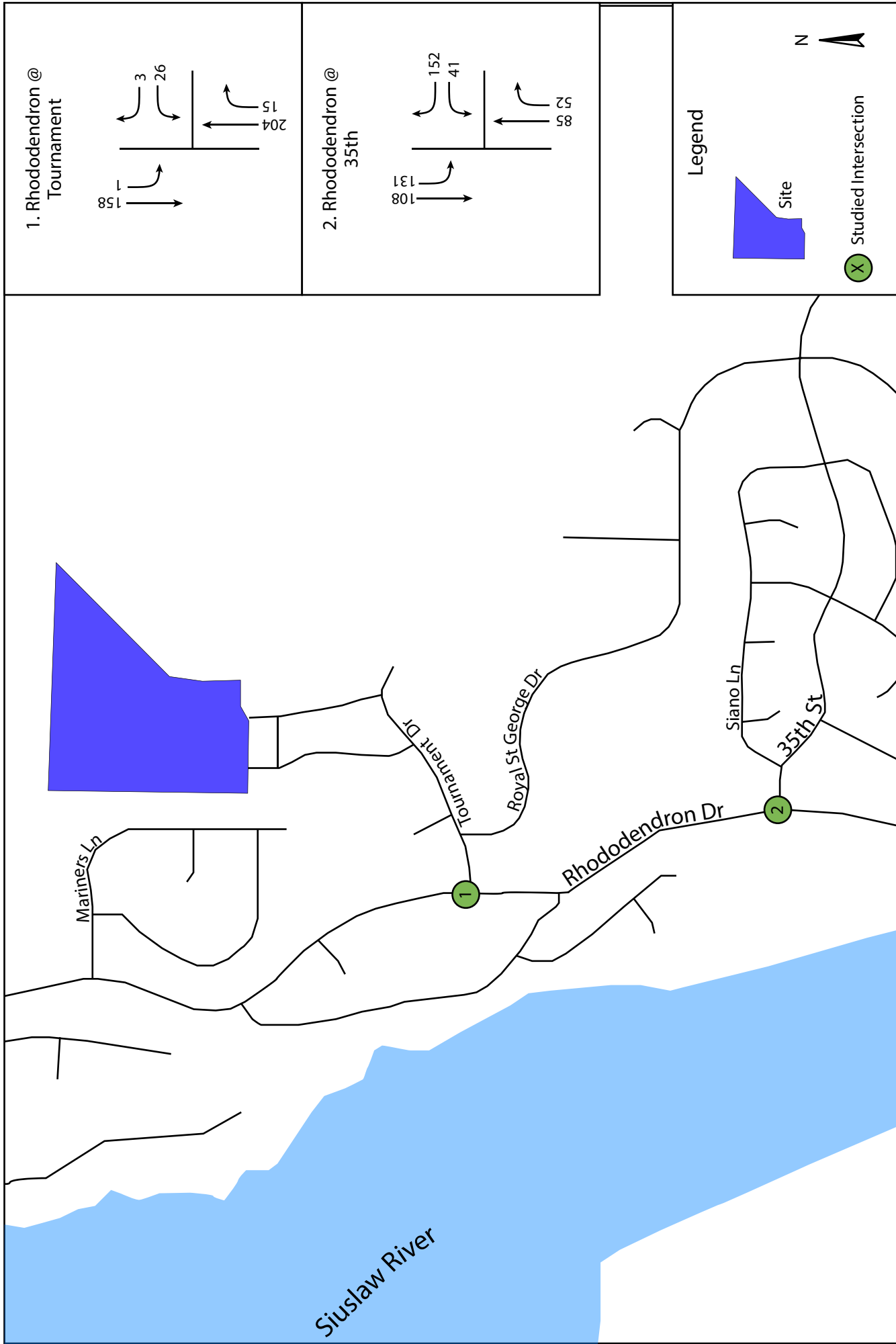

1. Rhododendron @
Tournament

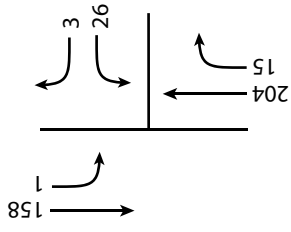

2. Rhododendron @
35th

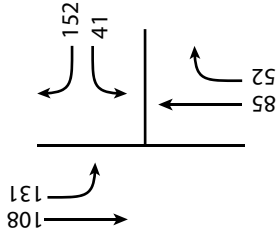

Legend

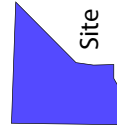

Fairway Estates, Florence, OR

Figure 6: Year 2022 PM Background Traffic Volumes



Figure 7: Year 2024 AM Peak Hour Traffic Volumes

Fairway Estates, Florence, OR



Fairway Estates, Florence, OR

Figure 8: Year 2024 PM Peak Hour Traffic Volumes

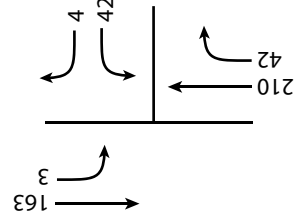

Figure 9: Year 2029 AM Peak Hour Traffic Volumes

Fairway Estates, Florence, OR



1. Rhododendron @ Tournament



1. Rhododendron @ Tournament

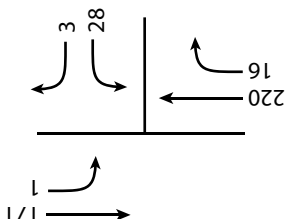

2. Rhododendron @ 35th

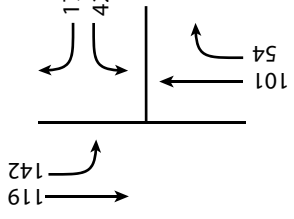

2. Rhododendron @ 35th

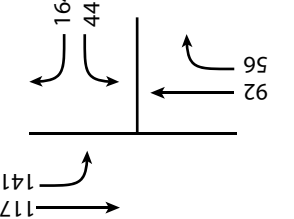

Legend

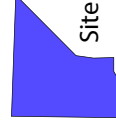

Site



Studied Intersection



N

Fairway Estates, Florence, OR

Figure 10: Year 2029 PM Peak Hour Traffic Volumes

5.0 INTERSECTION ANALYSIS

5.1 PERFORMANCE MEASURES

The measure of performance for the site access and intersections is the volume-to-capacity ratio (v/c) and Level of Service (LOS).

The volume-to-capacity ratio (v/c) describes the capability of an intersection to meet volume demand based upon the maximum number of vehicles that could be served in an hour.

LOS is a measure of performance for intersections in this analysis is based on the Highway Capacity Manual (HCM). LOS is a concept developed to quantify the degree of comfort (including such elements as travel time, number of stops, total amount of stopped delay, and impediments caused by other vehicles) afforded to drivers as they travel through an intersection or along a roadway segment. It was developed to quantify the quality of service of transportation facilities.

LOS is based on average delay, defined as the average total elapsed time from when a vehicle stops at the end of a queue until the vehicle departs from the stop line. The average delay is measured in seconds per vehicle per hour and then translated into a grade or “level of service” for each intersection. LOS ranges from A to F, with A indicating the most desirable condition and F indicating the most unsatisfactory condition.

The LOS criteria, as defined by the Highway Capacity Manual for signalized intersections, are provided in Table 4.

TABLE 4: HCM LEVEL OF SERVICE FOR INTERSECTIONS

	Stopped Delay Per Vehicle (Seconds per Vehicle)	
	Unsignalized Intersections	Signalized Intersections
A	≤ 10.0	≤ 10
B	> 10.0 and ≤ 15.0	> 10 and ≤ 20
C	> 15.0 and ≤ 25.0	> 20 and ≤ 35
D	> 25.0 and ≤ 35.0	> 35 and ≤ 55
E	> 35.0 and ≤ 50.0	> 55 and ≤ 80
F	> 50.0	> 80

The City of Florence uses a LOS standards are:

- Unsignalized intersections:
LOS= D

5.2 INTERSECTION ANALYSIS RESULTS

A performance analysis was conducted for the studied intersections for the Year 2021, 2024, and 2029 conditions during the AM and PM peak hours. The intersection evaluation was performed using Synchro 10 following HCM 6 critical movement methodology outlined in ODOT’s analysis Procedures Manual. The results are shown in Table 5 for the AM peak hour and Table 6 for the PM peak hour. The SYNCHRO outputs are provided in Appendix D.

TABLE 5: INTERSECTION PERFORMANCE: WEEKDAY AM PEAK HOUR

Intersection	Mobility Standard LOS	2022	2024 Background	2024 Build	2029 Background	2029 Build
Rhododendron at Tournament	LOS D	B	B	B	B	B
Rhododendron at 35th	LOS D	B	B	B	B	B

*Results reported for highest movement

TABLE 6: INTERSECTION PERFORMANCE: WEEKDAY PM PEAK HOUR

Intersection	Mobility Standard LOS	2022	2024 Background	2023 Build	2028 Background	2028 Build
Rhododendron at Tournament	LOS D	B	B	B	B	B
Rhododendron at 35th	LOS D	B	B	B	B	B

*Results reported for highest movement

As illustrated in Table 5 all intersections meet the mobility standards.

5.3 QUEUE ANALYSIS

A queuing analysis was conducted for the studied intersections. The analysis was performed using SimTraffic, a microsimulation software tool that uses the HCM defined criteria to estimate the queuing of vehicles within the study area. The average and 95th percentile queuing results are illustrated in Table 8 for the AM Peak Hour and Table 9 for the AM peak hour. All results are rounded to 25 feet to represent the total number of vehicles in the queue, as one vehicle typically occupies 25 feet of space. The SimTraffic outputs are provided in Appendix F.

TABLE 8: INTERSECTION QUEUING: WEEKDAY AM PEAK HOUR

Intersection	Available Storage (Feet)	2021 No-Build (Feet)		2024 No-Build (Feet)		2024 Build (Feet)		2029 No-Build (Feet)		2029 Build (Feet)		
		Average	95 th	Average	95 th	Average	95 th	Average	95 th	Average	95 th	
Rhododendron @ Tournament	WB	200	25	50	25	50	25	50	25	50	25	50
	NB	1200	0	0	0	0	0	0	0	0	0	0
	SB	500	0	25	0	25	0	0	0	25	0	25
Rhododendron @ 35th	WB	125	50	75	50	75	50	75	50	75	50	75
	NB	125	0	25	0	25	0	25	0	25	0	25
	SB	1200	25	75	25	75	25	75	25	75	25	75

TABLE 9: INTERSECTION QUEUING: WEEKDAY PM PEAK HOUR

Intersection	Available Storage (Feet)	2021 No-Build (Feet)		2024 No-Build (Feet)		2024 Build (Feet)		2029 No-Build (Feet)		2029 Build (Feet)		
		Average	95 th	Average	95 th	Average	95 th	Average	95 th	Average	95 th	
Rhododendron @ Tournament	WB	200	25	50	25	50	50	75	50	75	50	75
	NB	1200	0	0	0	0	0	0	0	0	0	0
	SB	500	0	25	0	25	0	5	0	25	0	25
Rhododendron @ 35th	WB	125	75	100	75	100	75	100	75	100	75	100
	NB	125	0	25	25	25	25	25	0	25	0	25
	SB	1200	25	75	50	75	50	75	50	75	50	100

As demonstrated in Tables 8 and 9, the addition of development traffic does not substantially increase the queuing conditions at the studied intersections.

6.0 CONCLUSION

The report provides a Traffic Impact Analysis and findings prepared for Fairway Estates 42-unit residential subdivision located in Florence, Oregon.

FINDINGS

- The addition of development trips does not trigger intersection mitigation.
- The addition of development trips does not increase queuing conditions at the study area intersections.
- The site accesses will operate safely and efficiently for all modes of travel.
- The site will have safe and adequate access for pedestrians and bicycles to and within the site.

Fairway Estates

**PROPOSED LAYOUT
FOR
FAIRVIEW ESTATES PHASE 2**
SW 1/4, SECTION 15, TOWNSHIP 18 SOUTH, RANGE 12 WEST, W.M.
FLORENCE, LANE COUNTY, OREGON
DATE PREPARED: AUGUST 2, 2021

CURVE TABLE

CURVE #	CHORD	RADIUS	LENGTH	DELTA
C1	N14°56'46"W 10.55'	20.00	10.68	30°35'11"
C2	N15°12'02"W 29.27'	56.40	29.61	30°04'38"
C3	N22°34'01"E 43.58'	56.40	44.75	45°27'29"
C4	N68°01'30"E 43.58'	56.40	44.75	45°27'29"
C5	S74°12'25"E 29.27'	56.40	29.61	30°04'40"
C6	S74°27'41"E 10.55'	20.00	10.68	30°35'12"
C7	S45°17'46"W 42.39'	30.00	47.07	89°53'53"
C8	N74°48'37"E 10.65'	20.00	10.78	30°52'13"
C9	N77°09'17"E 34.44'	56.40	35.00	35°33'34"
C10	S57°51'35"E 51.57'	56.40	53.56	54°24'43"
C11	S18°59'38"W 50.46'	56.40	52.31	53°08'34"
C12	S59°52'29"W 27.88'	56.40	28.17	28°37'08"
C13	S58°44'57"W 10.65'	20.00	10.78	30°52'13"
C14	N23°13'13"W 55.04'	30.00	69.67	133°04'08"
C15	N33°43'04"E 40.01'	120.00	40.20	19°11'33"
C16	N14°38'34"E 39.52'	120.00	39.70	18°57'27"
C17	S24°14'20"W 52.29'	80.00	53.27	38°09'00"
C18	N0°36'46"E 19.04'	120.00	19.06	9°06'09"
C19	S0°36'46"W 12.70'	80.00	12.71	9°06'09"
C20	N45°17'47"E 109.22'	56.40	148.71	151°04'16"
C21	S23°13'13"E 111.86'	56.40	191.76	194°48'33"
C22	N24°14'20"E 78.43'	120.00	79.90	38°09'00"
C23	N14°56'46"W 21.10'	40.00	21.35	30°35'11"
C24	N45°17'47"E 70.49'	36.40	95.98	151°04'16"
C25	S74°27'41"E 21.10'	40.00	21.35	30°35'12"
C26	N74°48'37"E 21.29'	40.00	21.55	30°52'13"
C27	S23°13'13"E 72.19'	36.40	123.76	194°48'33"
C28	S58°44'57"W 21.29'	40.00	21.55	30°52'12"
C29	S24°14'20"W 65.36'	100.00	66.58	38°09'00"
C30	S0°36'46"W 15.87'	100.00	15.89	9°06'09"
C31	S19°06'56"E 22.56'	56.40	22.72	23°04'34"

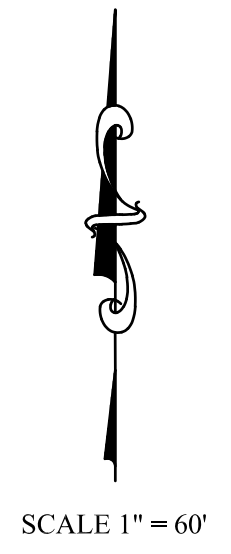

NOTES:
1. ONLY VISIBLE EVIDENCE OF UNDERGROUND UTILITIES ARE LOCATED. THIS SURVEY WAS MADE WITHOUT BENEFIT OF A TITLE REPORT. EASEMENTS, BOTH IMPLIED AND OF RECORD, NOT SHOWN ON THIS MAP MAY EXIST.
2. BOUNDARIES SHOWN ARE RECORD.

ELEVATION DATUM = NGVD 1929 +/- 0.2
TBM = MAG NAIL W200 - ELEVATION 66.47

Map compiled from record data, Lane County GIS Shapefiles, Aerial photos, and Dogami Lidar data. Survey field data was not gathered, and this map is not a survey.

REGISTERED PROFESSIONAL LAND SURVEYOR OREGON JULY 30, 1976 EUGENE M. WOBBE 1093 P.L.S. EXPIRATION DATE: 6-30-2022	T2021188843YA TOPO 2-21-2021_TRV DC202118843Y FWE PH2 222.DCD
	WOBBE & ASSOCIATES, INC. 510 KINGWOOD ST. / P.O. BOX 3093 FLORENCE, OR 97439 TOPOGRAPHIC SURVEY FOR: MICHAEL PEARSON
SW 1/4, SEC. 15, T 18 S, R 12 W, W.M. LANE COUNTY, OREGON	
DATE: FEB 21, 2021	DRAWN: EMW

METRO PLANNING, INC

846 A STREET
SPRINGFIELD, OR. 97477
541-302-9830
JOB NO. 21-051



Fairway Estates

CITY OF FLORENCE, LANE COUNTY

RHODODENDRON DR at 35TH ST, City of Florence, Lane County, 01/01/2016 to 12/31/2020

SER#	P	R	J	S	W	DATE	CLASS	CITY STREET	RD CHAR	INT-TYPE	SPCL USE	MOVE	A	S	INVEST	E	A	U	I	C	O	DAY	DIST	FIRST STREET	RD CHAR	(MEDIAN)	INT-REL	OFFRD	WTHR	CRASH	TRLR QTY	OWNER	FROM	PRTC	INJ	G	E	LICNS	PED	RD DPT	E	L	G	N	H	R	TIME	FROM	SECOND STREET	DIRECT	LEGS	TRAF-	RNDBT	SURF	COLL	OWNER	FROM	PRTC	INJ	G	E	LICNS	PED	UNLOC?	D	C	S	V	L	K	LAT	LONG	LRS	LOCTN	(#LANES)	CONTL	DRVWY	LIGHT	SVRTY	V#	TYPE	TO	P#	TYPE	SVRTY	E	X	RES	LOC	ERROR	ACT	EVENT	CAUSE
------	---	---	---	---	---	------	-------	-------------	---------	----------	----------	------	---	---	--------	---	---	---	---	---	---	-----	------	--------------	---------	----------	---------	-------	------	-------	----------	-------	------	------	-----	---	---	-------	-----	--------	---	---	---	---	---	---	------	------	---------------	--------	------	-------	-------	------	------	-------	------	------	-----	---	---	-------	-----	--------	---	---	---	---	---	---	-----	------	-----	-------	----------	-------	-------	-------	-------	----	------	----	----	------	-------	---	---	-----	-----	-------	-----	-------	-------

Disclaimer: The information contained in this report is compiled from individual driver and police crash reports submitted to the Oregon Department of Transportation as required in ORS 811.720. The Crash Analysis and Reporting Unit is committed to providing the highest quality crash data to customers. However, because submittal of crash report forms is the responsibility of the individual driver, the Crash Analysis and Reporting Unit can not guarantee that all qualifying crashes are represented nor can assurances be made that all details pertaining to a single crash are accurate. Note: Legislative changes to DMV's vehicle crash reporting requirement, effective 01/01/2004, may result in fewer property damage only crashes being eligible for inclusion in the Statewide Crash Data File.

05/04/2022

TRANSPORTATION DATA SECTION - CRASH ANALYSIS AND REPORTING UNIT

CRASH SUMMARIES BY YEAR BY COLLISION TYPE

RHODODENDRON DR at 35TH ST, City of Florence, Lane County, 01/01/2016 to 12/31/2020

COLLISION TYPE	FATAL CRASHES	NON- FATAL CRASHES	PROPERTY DAMAGE ONLY	TOTAL CRASHES	PEOPLE KILLED	PEOPLE INJURED	TRUCKS	DRY SURF	WET SURF	DAY	DARK	INTER- SECTION	SECTION RELATED	OFF- ROAD
FINAL TOTAL														

Disclaimer: The information contained in this report is compiled from individual driver and police crash reports submitted to the Oregon Department of Transportation as required in ORS 811.720. The Crash Analysis and Reporting Unit is committed to providing the highest quality crash data to customers. However, because submittal of crash report forms is the responsibility of the individual driver, the Crash Analysis and Reporting Unit can not guarantee that all qualifying crashes are represented nor can assurances be made that all details pertaining to a single crash are accurate. Note: Legislative changes to DMV's vehicle crash reporting requirements, effective 01/01/2004, may result in fewer property damage only crashes being eligible for inclusion in the Statewide Crash Data File.

Fairway Estates

APPENDIX C: TRAFFIC VOLUMES

Intersection: **1: Rhododendron @ 35th St** City: **Veneta, OR**
 Counter: **Quality Counts** Date: **Wednesday, February 23, 2022**

Time Period	Southbound				Westbound				Northbound				Eastbound				15 Minute Volume	Hourly Volume	Pedestrians			
	Right	Thru	Left	Approach Total	Right	Thru	Left	Approach Total	Right	Thru	Left	Approach Total	Right	Thru	Left	Approach Total			SB	WB	NB	EB
7:00-7:15	0	4	10	14	12	0	4	16	2	3	0	5	0	0	0	0	35	0	0	0	0	
7:15-7:30	0	8	16	24	9	0	4	13	2	7	0	9	0	0	0	0	46	0	0	0	0	
7:30-7:45	0	14	19	33	12	0	3	15	5	2	0	7	0	0	0	0	55	0	0	0	0	
7:45-8:00	0	15	19	34	14	0	6	20	7	8	0	15	0	0	0	0	69	205	0	0	0	0
8:00-8:15	0	12	9	21	17	0	8	25	2	5	0	7	0	0	0	0	53	223	0	0	0	0
8:15-8:30	0	10	22	32	12	0	8	20	5	11	0	16	0	0	0	0	68	245	0	0	0	0
8:30-8:45	0	15	28	43	16	0	7	23	11	8	0	19	0	0	0	0	85	275	0	0	0	0
8:45-9:00	0	22	28	50	13	0	9	22	11	11	0	22	0	0	0	0	94	300	0	0	0	0
9:00-9:15	0	0	0	0	0	0	0	0	0	0	0	0	0	0	0	0	0	0	0	0	0	0
9:15-9:30	0	0	0	0	0	0	0	0	0	0	0	0	0	0	0	0	0	0	0	0	0	0
9:30-9:45	0	0	0	0	0	0	0	0	0	0	0	0	0	0	0	0	0	0	0	0	0	0
9:45-10:00	0	0	0	0	0	0	0	0	0	0	0	0	0	0	0	0	0	0	0	0	0	0
Count Period Total	0	100	151		105	0	49		45	55	0		0	0	0		505		0	0	0	0

PM Peak Hour Count Summary																							
Peak Volumes	Southbound				Westbound				Northbound				Eastbound				Approach	300	0.80	Pedestrians			
	Right	Thru	Left	Approach	Right	Thru	Left	Approach	Right	Thru	Left	Approach	Right	Thru	Left	Approach				SB	WB	NB	EB
	0	59	87	146	58	0	32	90	29	35	0	64	0	0	0	0	0	0	0	0			
PHF	0.00	0.67	0.78	0.73	0.85	0.00	0.89	0.90	0.66	0.80	0.00	0.73	0.00	0.00	0.00	0.00	0.80						
Trucks	0	8	12		4	0	4		0	0	0		0	0	0								
% Trucks	0%	14%	14%		7%	0%	13%		0%	0%	0%		0%	0%	0%								

Seasonally Adjusted Peak Hour

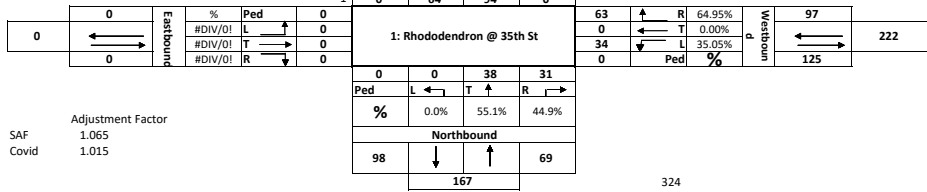

Adjustment Factor
 SAF 1.065
 Covid 1.015

324

Seasonally Adjusted Peak Hour

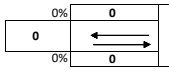

%	Ped	0
0.00%	L ↑	0
0.00%	T →	0
#DIV/0!	R ↓	0

61%	262	36%	
164	↓	↑	97
Southbound			
0.00%	99.24%	0.76%	%
R ←	T ↓	L →	PED
0	163	1	0
2: Rhododendron @ Tournament			
0	0	96	4
Ped	L ←	T ↑	R →
%	0.0%	96.3%	3.8%
Northbound			
167	↓	↑	100
62%	267	37%	

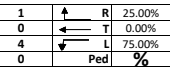

1	↑	R	25.00%
0	←	T	0.00%
4	↓	L	75.00%
0	Ped	%	

Adjustment Factor
1.246

SAF

269

Global Peak Hour

Intersections					
	1: Rhododendron @ 35th St	2: Rhododendron @ Tournament			
Time Period	Volume	Volume	Volume	Volume	Total
7:00 AM 8:00 AM	205	135			340
7:15 AM 8:15 AM	223	184			407
7:30 AM 8:30 AM	245	215			460
7:45 AM 8:45 AM	275	229			504
8:00 AM 9:00 AM	300	216	0		516
	275	229	0	0	516

Peak Hour 8:00 AM
 8:15 AM
 8:30 AM
 8:45 AM

2021 Base		2021 with pipeline trips																																																																																																																																																																																																																																									
<table border="1"> <tr><td colspan="2">2021</td><td>164</td><td>98</td><td></td></tr> <tr><td></td><td>R</td><td>T</td><td>L</td><td>PED</td></tr> <tr><td>1</td><td>0</td><td>0</td><td>163</td><td>1</td><td>0</td></tr> <tr><td>Ped</td><td>0</td><td>0</td><td>0</td><td>0</td><td>1R</td></tr> <tr><td>0</td><td>0</td><td>0</td><td>0</td><td>0</td><td>0T</td></tr> <tr><td>0</td><td>0</td><td>0</td><td>0</td><td>4</td><td>4L</td></tr> <tr><td>0</td><td>0</td><td>0</td><td>0</td><td>0</td><td>0Ped</td></tr> <tr><td colspan="2"></td><td>0</td><td>0</td><td>97</td><td>4</td></tr> <tr><td>Ped</td><td>L</td><td>T</td><td>R</td><td></td><td></td></tr> <tr><td colspan="2"></td><td>167</td><td>101</td><td></td><td></td></tr> </table> <table border="1"> <tr><td colspan="2">2021</td><td>167</td><td>101</td><td></td></tr> <tr><td></td><td>R</td><td>T</td><td>L</td><td>PED</td></tr> <tr><td>2</td><td>0</td><td>0</td><td>67</td><td>100</td><td>0</td></tr> <tr><td>Ped</td><td>0</td><td>0</td><td>0</td><td>0</td><td>63R</td></tr> <tr><td>0</td><td>0</td><td>0</td><td>0</td><td>0</td><td>0T</td></tr> <tr><td>0</td><td>0</td><td>0</td><td>0</td><td>34</td><td>34L</td></tr> <tr><td>0</td><td>0</td><td>0</td><td>0</td><td>0</td><td>0Ped</td></tr> <tr><td colspan="2"></td><td>0</td><td>0</td><td>38</td><td>31</td></tr> <tr><td>Ped</td><td>L</td><td>T</td><td>R</td><td></td><td></td></tr> <tr><td colspan="2"></td><td>101</td><td>69</td><td></td><td>333</td></tr> </table>		2021		164	98			R	T	L	PED	1	0	0	163	1	0	Ped	0	0	0	0	1R	0	0	0	0	0	0T	0	0	0	0	4	4L	0	0	0	0	0	0Ped			0	0	97	4	Ped	L	T	R					167	101			2021		167	101			R	T	L	PED	2	0	0	67	100	0	Ped	0	0	0	0	63R	0	0	0	0	0	0T	0	0	0	0	34	34L	0	0	0	0	0	0Ped			0	0	38	31	Ped	L	T	R					101	69		333	<table border="1"> <tr><td colspan="2">2021 with pipeline trips</td><td>176</td><td>106</td><td></td></tr> <tr><td></td><td>R</td><td>T</td><td>L</td><td>PED</td></tr> <tr><td>0</td><td>0</td><td>0</td><td>174</td><td>2</td><td>0</td></tr> <tr><td>Ped</td><td>0</td><td>0</td><td>0</td><td>0</td><td>4R</td></tr> <tr><td>0</td><td>0</td><td>0</td><td>0</td><td>0</td><td>0T</td></tr> <tr><td>0</td><td>0</td><td>0</td><td>4</td><td>0</td><td>15L</td></tr> <tr><td>0</td><td>0</td><td>0</td><td>0</td><td>0</td><td>0Ped</td></tr> <tr><td colspan="2"></td><td>0</td><td>0</td><td>102</td><td>8</td></tr> <tr><td>Ped</td><td>L</td><td>T</td><td>R</td><td></td><td></td></tr> <tr><td colspan="2"></td><td>189</td><td>110</td><td></td><td>305</td></tr> </table> <table border="1"> <tr><td colspan="2">2021 with pipeline trips</td><td>244</td><td>128</td><td></td></tr> <tr><td></td><td>R</td><td>T</td><td>L</td><td>PED</td></tr> <tr><td>0</td><td>0</td><td>0</td><td>108</td><td>136</td><td>0</td></tr> <tr><td>Ped</td><td>0</td><td>0</td><td>0</td><td>0</td><td>75R</td></tr> <tr><td>0</td><td>0</td><td>0</td><td>0</td><td>0</td><td>0T</td></tr> <tr><td>0</td><td>0</td><td>0</td><td>0</td><td>34</td><td>34L</td></tr> <tr><td>0</td><td>0</td><td>0</td><td>0</td><td>0</td><td>0Ped</td></tr> <tr><td colspan="2"></td><td>0</td><td>0</td><td>53</td><td>31</td></tr> <tr><td>Ped</td><td>L</td><td>T</td><td>R</td><td></td><td></td></tr> <tr><td colspan="2"></td><td>142</td><td>84</td><td></td><td>109</td></tr> </table>		2021 with pipeline trips		176	106			R	T	L	PED	0	0	0	174	2	0	Ped	0	0	0	0	4R	0	0	0	0	0	0T	0	0	0	4	0	15L	0	0	0	0	0	0Ped			0	0	102	8	Ped	L	T	R					189	110		305	2021 with pipeline trips		244	128			R	T	L	PED	0	0	0	108	136	0	Ped	0	0	0	0	75R	0	0	0	0	0	0T	0	0	0	0	34	34L	0	0	0	0	0	0Ped			0	0	53	31	Ped	L	T	R					142	84		109
2021		164	98																																																																																																																																																																																																																																								
	R	T	L	PED																																																																																																																																																																																																																																							
1	0	0	163	1	0																																																																																																																																																																																																																																						
Ped	0	0	0	0	1R																																																																																																																																																																																																																																						
0	0	0	0	0	0T																																																																																																																																																																																																																																						
0	0	0	0	4	4L																																																																																																																																																																																																																																						
0	0	0	0	0	0Ped																																																																																																																																																																																																																																						
		0	0	97	4																																																																																																																																																																																																																																						
Ped	L	T	R																																																																																																																																																																																																																																								
		167	101																																																																																																																																																																																																																																								
2021		167	101																																																																																																																																																																																																																																								
	R	T	L	PED																																																																																																																																																																																																																																							
2	0	0	67	100	0																																																																																																																																																																																																																																						
Ped	0	0	0	0	63R																																																																																																																																																																																																																																						
0	0	0	0	0	0T																																																																																																																																																																																																																																						
0	0	0	0	34	34L																																																																																																																																																																																																																																						
0	0	0	0	0	0Ped																																																																																																																																																																																																																																						
		0	0	38	31																																																																																																																																																																																																																																						
Ped	L	T	R																																																																																																																																																																																																																																								
		101	69		333																																																																																																																																																																																																																																						
2021 with pipeline trips		176	106																																																																																																																																																																																																																																								
	R	T	L	PED																																																																																																																																																																																																																																							
0	0	0	174	2	0																																																																																																																																																																																																																																						
Ped	0	0	0	0	4R																																																																																																																																																																																																																																						
0	0	0	0	0	0T																																																																																																																																																																																																																																						
0	0	0	4	0	15L																																																																																																																																																																																																																																						
0	0	0	0	0	0Ped																																																																																																																																																																																																																																						
		0	0	102	8																																																																																																																																																																																																																																						
Ped	L	T	R																																																																																																																																																																																																																																								
		189	110		305																																																																																																																																																																																																																																						
2021 with pipeline trips		244	128																																																																																																																																																																																																																																								
	R	T	L	PED																																																																																																																																																																																																																																							
0	0	0	108	136	0																																																																																																																																																																																																																																						
Ped	0	0	0	0	75R																																																																																																																																																																																																																																						
0	0	0	0	0	0T																																																																																																																																																																																																																																						
0	0	0	0	34	34L																																																																																																																																																																																																																																						
0	0	0	0	0	0Ped																																																																																																																																																																																																																																						
		0	0	53	31																																																																																																																																																																																																																																						
Ped	L	T	R																																																																																																																																																																																																																																								
		142	84		109																																																																																																																																																																																																																																						

EDIT Highlighted		2022 AM Volumes Background																																																																																																																					
Base Year	2021																																																																																																																						
Target Year	2024																																																																																																																						
Years of Growth	3																																																																																																																						
Growth Rate Per Year	0.010																																																																																																																						
Growth Factor	1.03																																																																																																																						
<table border="1"> <tr><td colspan="2">2022 AM</td><td>182</td><td>109</td><td></td></tr> <tr><td></td><td>R</td><td>T</td><td>L</td><td>PED</td></tr> <tr><td>1</td><td>0</td><td>0</td><td>179</td><td>2</td><td>0</td></tr> <tr><td>Ped</td><td>0</td><td>0</td><td>0</td><td>0</td><td>4R</td></tr> <tr><td>0</td><td>0</td><td>0</td><td>0</td><td>0</td><td>0T</td></tr> <tr><td>0</td><td>0</td><td>0</td><td>0</td><td>15</td><td>15L</td></tr> <tr><td>0</td><td>0</td><td>0</td><td>0</td><td>0</td><td>0Ped</td></tr> <tr><td colspan="2"></td><td>0</td><td>0</td><td>105</td><td>8</td></tr> <tr><td>Ped</td><td>L</td><td>T</td><td>R</td><td></td><td></td></tr> <tr><td colspan="2"></td><td>195</td><td>113</td><td></td><td></td></tr> </table> <table border="1"> <tr><td colspan="2">2022 AM</td><td>251</td><td>132</td><td></td></tr> <tr><td></td><td>R</td><td>T</td><td>L</td><td>PED</td></tr> <tr><td>1</td><td>0</td><td>0</td><td>111</td><td>140</td><td>0</td></tr> <tr><td>Ped</td><td>0</td><td>0</td><td>0</td><td>0</td><td>77R</td></tr> <tr><td>0</td><td>0</td><td>0</td><td>0</td><td>0</td><td>0T</td></tr> <tr><td>0</td><td>0</td><td>0</td><td>0</td><td>35</td><td>35L</td></tr> <tr><td>0</td><td>0</td><td>0</td><td>0</td><td>0</td><td>0Ped</td></tr> <tr><td colspan="2"></td><td>0</td><td>0</td><td>55</td><td>32</td></tr> <tr><td>Ped</td><td>L</td><td>T</td><td>R</td><td></td><td></td></tr> <tr><td colspan="2"></td><td>146</td><td>87</td><td></td><td></td></tr> </table>		2022 AM		182	109			R	T	L	PED	1	0	0	179	2	0	Ped	0	0	0	0	4R	0	0	0	0	0	0T	0	0	0	0	15	15L	0	0	0	0	0	0Ped			0	0	105	8	Ped	L	T	R					195	113			2022 AM		251	132			R	T	L	PED	1	0	0	111	140	0	Ped	0	0	0	0	77R	0	0	0	0	0	0T	0	0	0	0	35	35L	0	0	0	0	0	0Ped			0	0	55	32	Ped	L	T	R					146	87				
2022 AM		182	109																																																																																																																				
	R	T	L	PED																																																																																																																			
1	0	0	179	2	0																																																																																																																		
Ped	0	0	0	0	4R																																																																																																																		
0	0	0	0	0	0T																																																																																																																		
0	0	0	0	15	15L																																																																																																																		
0	0	0	0	0	0Ped																																																																																																																		
		0	0	105	8																																																																																																																		
Ped	L	T	R																																																																																																																				
		195	113																																																																																																																				
2022 AM		251	132																																																																																																																				
	R	T	L	PED																																																																																																																			
1	0	0	111	140	0																																																																																																																		
Ped	0	0	0	0	77R																																																																																																																		
0	0	0	0	0	0T																																																																																																																		
0	0	0	0	35	35L																																																																																																																		
0	0	0	0	0	0Ped																																																																																																																		
		0	0	55	32																																																																																																																		
Ped	L	T	R																																																																																																																				
		146	87																																																																																																																				

EDIT Highlighted		2027 AM Volumes Background																																																																																																																					
Base Year	2021																																																																																																																						
Target Year	2029																																																																																																																						
Years of Growth	8																																																																																																																						
Growth Rate Per Year	0.010																																																																																																																						
Growth Factor	1.08																																																																																																																						
<table border="1"> <tr><td colspan="2">2027 AM</td><td>191</td><td>115</td><td></td></tr> <tr><td></td><td>R</td><td>T</td><td>L</td><td>PED</td></tr> <tr><td>1</td><td>0</td><td>0</td><td>188</td><td>2</td><td>0</td></tr> <tr><td>Ped</td><td>0</td><td>0</td><td>0</td><td>0</td><td>5R</td></tr> <tr><td>0</td><td>0</td><td>0</td><td>0</td><td>0</td><td>0T</td></tr> <tr><td>0</td><td>0</td><td>0</td><td>0</td><td>16</td><td>16L</td></tr> <tr><td>0</td><td>0</td><td>0</td><td>0</td><td>0</td><td>0Ped</td></tr> <tr><td colspan="2"></td><td>0</td><td>0</td><td>110</td><td>8</td></tr> <tr><td>Ped</td><td>L</td><td>T</td><td>R</td><td></td><td></td></tr> <tr><td colspan="2"></td><td>204</td><td>119</td><td></td><td></td></tr> </table> <table border="1"> <tr><td colspan="2">2027 AM</td><td>264</td><td>138</td><td></td></tr> <tr><td></td><td>R</td><td>T</td><td>L</td><td>PED</td></tr> <tr><td>1</td><td>0</td><td>0</td><td>117</td><td>147</td><td>0</td></tr> <tr><td>Ped</td><td>0</td><td>0</td><td>0</td><td>0</td><td>81R</td></tr> <tr><td>0</td><td>0</td><td>0</td><td>0</td><td>0</td><td>0T</td></tr> <tr><td>0</td><td>0</td><td>0</td><td>0</td><td>37</td><td>37L</td></tr> <tr><td>0</td><td>0</td><td>0</td><td>0</td><td>0</td><td>0Ped</td></tr> <tr><td colspan="2"></td><td>0</td><td>0</td><td>57</td><td>33</td></tr> <tr><td>Ped</td><td>L</td><td>T</td><td>R</td><td></td><td></td></tr> <tr><td colspan="2"></td><td>153</td><td>91</td><td></td><td>118</td></tr> </table>		2027 AM		191	115			R	T	L	PED	1	0	0	188	2	0	Ped	0	0	0	0	5R	0	0	0	0	0	0T	0	0	0	0	16	16L	0	0	0	0	0	0Ped			0	0	110	8	Ped	L	T	R					204	119			2027 AM		264	138			R	T	L	PED	1	0	0	117	147	0	Ped	0	0	0	0	81R	0	0	0	0	0	0T	0	0	0	0	37	37L	0	0	0	0	0	0Ped			0	0	57	33	Ped	L	T	R					153	91		118		
2027 AM		191	115																																																																																																																				
	R	T	L	PED																																																																																																																			
1	0	0	188	2	0																																																																																																																		
Ped	0	0	0	0	5R																																																																																																																		
0	0	0	0	0	0T																																																																																																																		
0	0	0	0	16	16L																																																																																																																		
0	0	0	0	0	0Ped																																																																																																																		
		0	0	110	8																																																																																																																		
Ped	L	T	R																																																																																																																				
		204	119																																																																																																																				
2027 AM		264	138																																																																																																																				
	R	T	L	PED																																																																																																																			
1	0	0	117	147	0																																																																																																																		
Ped	0	0	0	0	81R																																																																																																																		
0	0	0	0	0	0T																																																																																																																		
0	0	0	0	37	37L																																																																																																																		
0	0	0	0	0	0Ped																																																																																																																		
		0	0	57	33																																																																																																																		
Ped	L	T	R																																																																																																																				
		153	91		118																																																																																																																		

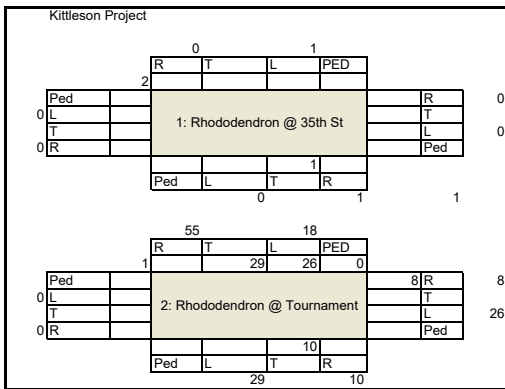
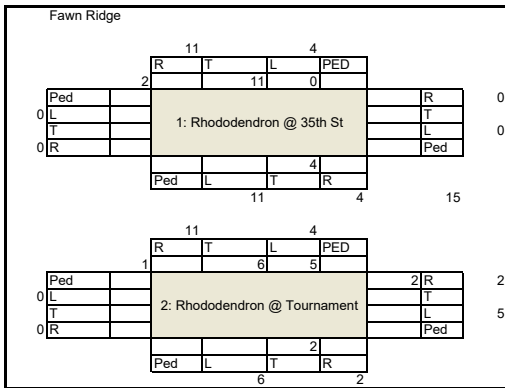
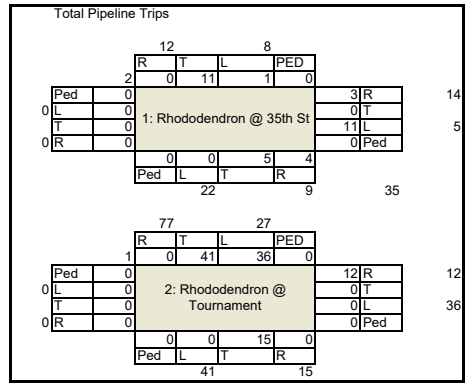
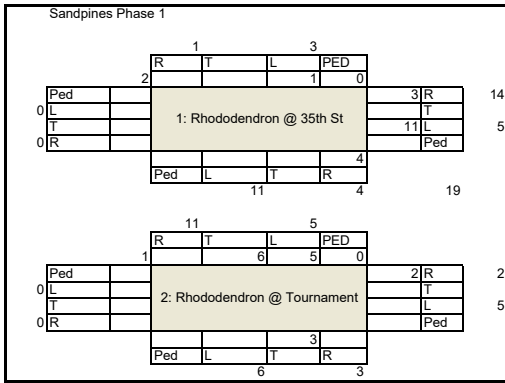

Intersection: **1: Rhododendron Dr @ 35 St** City: **Florence, OR**
 Counter: **Quality Counts** Date: **Thursday, August 27, 2020**

Time Period	Southbound				Westbound				Northbound				Eastbound				15 Minute Volume	Hourly Volume	Pedestrians			
	Right	Thru	Left	Approach Total	Right	Thru	Left	Approach Total	Right	Thru	Left	Approach Total	Right	Thru	Left	Approach Total			SB	WB	NB	EB
16:00 - 16:15	0	18	20	38	33	0	11	44	17	18	0	35	0	0	0	0	117	0	0	0	0	
16:15 - 16:30	0	17	30	47	28	0	5	33	13	14	0	27	0	0	0	0	107	0	0	0	0	
16:30 - 16:45	0	17	18	35	32	0	14	46	13	16	0	29	0	0	0	0	110	0	0	0	0	
16:45 - 17:00	0	10	20	30	37	0	8	45	5	17	0	22	0	0	0	0	97	0	0	0	0	
17:00 - 17:15	0	16	17	33	33	0	10	43	7	18	0	25	0	0	0	0	101	0	0	0	0	
17:15 - 17:30	0	18	18	36	26	0	8	34	5	18	0	23	0	0	0	0	93	0	0	0	0	
17:30 - 17:45	0	6	9	15	24	0	5	29	2	7	0	9	0	0	0	0	53	0	0	0	0	
17:45 - 18:00	0	18	14	32	22	0	0	22	4	7	0	11	0	0	0	0	65	0	0	0	0	
18:00 - 18:15	0	0	0	0	0	0	0	0	0	0	0	0	0	0	0	0	0	0	0	0	0	
18:15 - 18:30	0	0	0	0	0	0	0	0	0	0	0	0	0	0	0	0	0	0	0	0	0	
18:30 - 18:45	0	0	0	0	0	0	0	0	0	0	0	0	0	0	0	0	0	0	0	0	0	
18:45 - 19:00	0	0	0	0	0	0	0	0	0	0	0	0	0	0	0	0	0	0	0	0	0	
Count Period Total	0	120	146		235	0	61		66	115	0		0	0	0	0	743	0	0	0	0	

PM Peak Hour Count Summary																						
Peak Volumes	Southbound				Westbound				Northbound				Eastbound				Approach	Hourly Volume	Pedestrians			
	Right	Thru	Left	Approach	Right	Thru	Left	Approach	Right	Thru	Left	Approach	Right	Thru	Left	Approach			SB	WB	NB	EB
	0	62	88	150	130	0	38	168	48	65	0	113	0	0	0	0	431	0	0	0	0	
PHF	0.00	0.86	0.73	0.80	0.88	0.00	0.68	0.91	0.71	0.90	0.00	0.81	0.00	0.00	0.00	0.00	0.92					
Trucks	0	0	20		4	0	8		8	4	0		0	0	0							
% Trucks	0%	0%	23%		3%	0%	21%		17%	6%	0%		0%	0%	0%							

Seasonally Adjusted Peak Hour

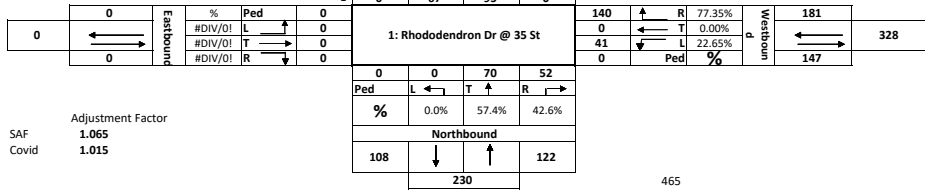

Adjustment Factor
 SAF 1.065
 Covid 1.015

1: Rhododendron Dr @ 35 St

Pedestrians and Cars

Time Period	Southbound				Westbound				Northbound				Eastbound				15 Minute Volume	Hourly Volume
	Peds	Right	Thru	Left	Peds	Right	Thru	Left	Peds	Right	Thru	Left	Peds	Right	Thru	Left		
4:00 PM			18	20		33		11		17	18						117	
4:15 PM			17	30		28		5		13	14						107	
4:30 PM			17	18		32		14		13	16						110	
4:45 PM			10	20		37		8		5	17						97	431
5:00 PM			16	17		33		10		7	18						101	415
5:15 PM			18	18		26		8		5	18						93	401
5:30 PM			6	9		24		5		2	7						53	344
5:45 PM			18	14		22		0		4	7						65	312
6:00 PM																	0	211
6:15 PM																	0	118
6:30 PM																	0	65
6:45 PM																	0	0
Total	0	0	120	146	0	235	0	61	0	0	66	115	0	0	0	0	401	1247
Peak Hour	0	0	61	73	0	128	0	40	0	0	30	69	0	0	0	0	401	1247

Trucks

Time Period	Southbound				Westbound				Northbound				Eastbound				15 Minute Volume	Hourly Volume
	Right	Thru	Left		Right	Thru	Left		Right	Thru	Left		Right	Thru	Left			
4:00 PM																	0	
4:15 PM																	0	
4:30 PM																	0	
4:45 PM																	0	0
5:00 PM																	0	0
5:15 PM																	0	0
5:30 PM																	0	0
5:45 PM																	0	0
6:00 PM																	0	0
6:15 PM																	0	0
6:30 PM																	0	0
6:45 PM																	0	0
Total	0	0	0		0	0	0		0	0	0	0	0	0	0		0	0
Peak Hour	0	0	0		0	0	0		0	0	0	0	0	0	0		0	0

Bikes

Time Period	Southbound			Westbound			Northbound			Eastbound			SB	WB	NB	EB
	Right	Thru	Left	Right	Thru	Left	Right	Thru	Left	Right	Thru	Left				
4:00 PM													0	0	0	0
4:15 PM													0	0	0	0
4:30 PM													0	0	0	0
4:45 PM													0	0	0	0
5:00 PM													0	0	0	0
5:15 PM													0	0	0	0
5:30 PM													0	0	0	0
5:45 PM													0	0	0	0
6:00 PM													0	0	0	0
6:15 PM													0	0	0	0
6:30 PM													0	0	0	0
6:45 PM													0	0	0	0
Total	0	0	0		0	0	0		0	0	0		0	0	0	0
Peak Hour	0	0	0		0	0	0		0	0	0		0	0	0	0

Pedestrians

Time Period	NE			NW			SW			SE			SB	WB	NB	EB
	Left	Right	Total	Left	Right	Total	Left	Right	Total	Left	Right	Total				
4:00 PM			0			0			0			0	0	0	0	0
4:15 PM			0			0			0			0	0	0	0	0
4:30 PM			0			0			0			0	0	0	0	0
4:45 PM			0			0			0			0	0	0	0	0
5:00 PM			0			0			0			0	0	0	0	0
5:15 PM			0			0			0			0	0	0	0	0
5:30 PM			0			0			0			0	0	0	0	0
5:45 PM			0			0			0			0	0	0	0	0
6:00 PM			0			0			0			0	0	0	0	0
6:15 PM			0			0			0			0	0	0	0	0
6:30 PM			0			0			0			0	0	0	0	0
6:45 PM			0			0			0			0	0	0	0	0
Total	0	0	0		0	0		0	0		0	0	0	0	0	0
Peak Hour	0	0	0		0	0		0	0		0	0	0	0	0	0

Intersection:		2: Rhododendron Dr @ Site Entrance								City: Florence, OR													
Counter:		Sandow Engineering								Date: Friday, October 21, 2022													
Total of All Vehicles																							
Time Period	Southbound				Westbound				Northbound				Eastbound				15 Minute Volume	Hourly Volume	Pedestrians				
	Right	Thru	Left	Approach Total	Right	Thru	Left	Approach Total	Right	Thru	Left	Approach Total	Right	Thru	Left	Approach Total			SB	WB	NB	EB	
16:00	16:15	0	28	0	28	0	0	6	6	2	42	0	44	0	0	0	0	78	261	0	0	0	0
16:15	16:30	0	28	0	28	0	0	2	2	2	34	0	36	0	0	0	0	66	277	0	0	0	0
16:30	16:45	0	26	0	26	0	0	4	4	2	40	0	42	0	0	0	0	72	258	0	1	0	1
16:45	17:00	0	26	0	26	0	0	0	0	3	37	0	40	0	0	0	0	66	246	0	0	0	0
17:00	17:15	0	21	0	21	0	0	1	1	0	35	0	35	0	0	0	0	57	0	0	0	0	0
17:15	17:30	0	22	0	22	4	0	3	7	2	51	0	53	0	0	0	0	82	0	0	0	0	0
17:30	17:45	0	18	0	18	1	0	0	1	1	33	0	34	0	0	0	0	53	0	1	0	0	0
17:45	18:00	0	21	2	23	0	0	0	0	0	31	0	31	0	0	0	0	54	0	0	0	0	0
18:00	18:15	0	0	0	0	0	0	0	0	0	0	0	0	0	0	0	0	0	0	0	0	0	0
18:15	18:30	0	0	0	0	0	0	0	0	0	0	0	0	0	0	0	0	0	0	0	0	0	0
18:30	18:45	0	0	0	0	0	0	0	0	0	0	0	0	0	0	0	0	0	0	0	0	0	0
18:45	19:00	0	0	0	0	0	0	0	0	0	0	0	0	0	0	0	0	0	0	0	0	0	0
Count Period Total		0	190	2	192	5	0	16	21	12	303	0	315	0	0	0	0	528	0	1	0	0	1
PM Peak Hour Count Summary																							
Peak Volumes	Southbound				Westbound				Northbound				Eastbound				Approach	15 Minute Volume	Hourly Volume	Pedestrians			
	Right	Thru	Left	Approach	Right	Thru	Left	Approach	Right	Thru	Left	Approach	Right	Thru	Left	Approach				SB	WB	NB	EB
	0	108	0	108	0	0	12	12	9	153	0	162	0	0	0	0	0	282	0	0	0	0	
PHF	0.00	0.96	0.00	0.96	0.00	0.00	0.50	0.50	0.75	0.91	0.00	0.92	0.00	0.00	0.00	0.00	0.00	0.90					
Trucks	0	1	0	1	0	0	2	2	0	0	0	0	0	0	0	0	0						
% Trucks	0%	1%	0%	1%	0%	0%	17%	17%	0%	0%	0%	0%	0%	0%	0%	0%	0%						

Seasonally Adjusted Peak Hour

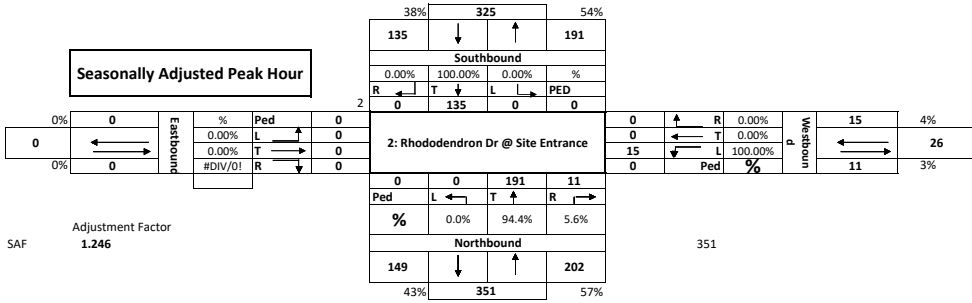

SAF Adjustment Factor
1.246

351

Global Peak Hour

Intersections					
		1: Rhododendron Dr @ 35 St	2: Rhododendron Dr @ Site Entrance		
Time Period		Volume	Volume		
4:00 PM	5:00 PM	431	282		
4:15 PM	5:15 PM	415	261		
4:30 PM	5:30 PM	401	277		
4:45 PM	5:45 PM	344	258		
5:00 PM	6:00 PM	312	246		
		431	282		

Peak Hour 4:00 PM
 4:15 PM
 4:30 PM
 4:45 PM

Total
713
676
678
602
558
713

2021 Base		2021 with pipeline trips																																																																																																																																																																																																																													
<table border="1"> <tr><td colspan="4">2021</td></tr> <tr><td>R</td><td>T</td><td>L</td><td>PED</td></tr> <tr><td>1</td><td>0</td><td>147</td><td>0</td></tr> <tr><td>Ped</td><td>0</td><td>0</td><td>0</td></tr> <tr><td>L</td><td>0</td><td>0</td><td>0</td></tr> <tr><td>T</td><td>0</td><td>0</td><td>0</td></tr> <tr><td>R</td><td>0</td><td>0</td><td>0</td></tr> <tr><td colspan="4">2: Rhododendron Dr @ Site Entrance</td></tr> <tr><td>0</td><td>0</td><td>0</td><td>11</td></tr> <tr><td>Ped</td><td>L</td><td>T</td><td>R</td></tr> <tr><td>0</td><td>0</td><td>199</td><td>11</td></tr> <tr><td colspan="4">162</td></tr> <tr><td>R</td><td>T</td><td>L</td><td>PED</td></tr> <tr><td>2</td><td>0</td><td>67</td><td>95</td></tr> <tr><td>Ped</td><td>0</td><td>0</td><td>0</td></tr> <tr><td>L</td><td>0</td><td>0</td><td>0</td></tr> <tr><td>T</td><td>0</td><td>0</td><td>0</td></tr> <tr><td>R</td><td>0</td><td>0</td><td>0</td></tr> <tr><td colspan="4">1: Rhododendron Dr @ 35 St</td></tr> <tr><td>0</td><td>0</td><td>0</td><td>52</td></tr> <tr><td>Ped</td><td>L</td><td>T</td><td>R</td></tr> <tr><td>0</td><td>0</td><td>70</td><td>52</td></tr> <tr><td colspan="4">108</td></tr> <tr><td colspan="4">122</td></tr> <tr><td colspan="4">465</td></tr> </table>		2021				R	T	L	PED	1	0	147	0	Ped	0	0	0	L	0	0	0	T	0	0	0	R	0	0	0	2: Rhododendron Dr @ Site Entrance				0	0	0	11	Ped	L	T	R	0	0	199	11	162				R	T	L	PED	2	0	67	95	Ped	0	0	0	L	0	0	0	T	0	0	0	R	0	0	0	1: Rhododendron Dr @ 35 St				0	0	0	52	Ped	L	T	R	0	0	70	52	108				122				465				<table border="1"> <tr><td colspan="4">2021 with pipeline trips</td></tr> <tr><td>R</td><td>T</td><td>L</td><td>PED</td></tr> <tr><td>0</td><td>2</td><td>159</td><td>207</td></tr> <tr><td>Ped</td><td>0</td><td>0</td><td>0</td></tr> <tr><td>L</td><td>0</td><td>158</td><td>1</td></tr> <tr><td>T</td><td>0</td><td>0</td><td>0</td></tr> <tr><td>R</td><td>0</td><td>0</td><td>0</td></tr> <tr><td colspan="4">2: Rhododendron Dr @ Site Entrance</td></tr> <tr><td>0</td><td>0</td><td>0</td><td>15</td></tr> <tr><td>Ped</td><td>L</td><td>T</td><td>R</td></tr> <tr><td>0</td><td>0</td><td>204</td><td>15</td></tr> <tr><td colspan="4">184</td></tr> <tr><td colspan="4">219</td></tr> <tr><td colspan="4">407</td></tr> <tr><td colspan="4">239</td></tr> <tr><td>R</td><td>T</td><td>L</td><td>PED</td></tr> <tr><td>2</td><td>0</td><td>108</td><td>131</td></tr> <tr><td>Ped</td><td>0</td><td>0</td><td>0</td></tr> <tr><td>L</td><td>0</td><td>0</td><td>0</td></tr> <tr><td>T</td><td>0</td><td>0</td><td>0</td></tr> <tr><td>R</td><td>0</td><td>0</td><td>0</td></tr> <tr><td colspan="4">1: Rhododendron Dr @ 35 St</td></tr> <tr><td>0</td><td>0</td><td>0</td><td>52</td></tr> <tr><td>Ped</td><td>L</td><td>T</td><td>R</td></tr> <tr><td>0</td><td>0</td><td>85</td><td>52</td></tr> <tr><td colspan="4">149</td></tr> <tr><td colspan="4">137</td></tr> <tr><td colspan="4">152</td></tr> <tr><td colspan="4">183</td></tr> <tr><td colspan="4">193</td></tr> </table>		2021 with pipeline trips				R	T	L	PED	0	2	159	207	Ped	0	0	0	L	0	158	1	T	0	0	0	R	0	0	0	2: Rhododendron Dr @ Site Entrance				0	0	0	15	Ped	L	T	R	0	0	204	15	184				219				407				239				R	T	L	PED	2	0	108	131	Ped	0	0	0	L	0	0	0	T	0	0	0	R	0	0	0	1: Rhododendron Dr @ 35 St				0	0	0	52	Ped	L	T	R	0	0	85	52	149				137				152				183				193			
2021																																																																																																																																																																																																																															
R	T	L	PED																																																																																																																																																																																																																												
1	0	147	0																																																																																																																																																																																																																												
Ped	0	0	0																																																																																																																																																																																																																												
L	0	0	0																																																																																																																																																																																																																												
T	0	0	0																																																																																																																																																																																																																												
R	0	0	0																																																																																																																																																																																																																												
2: Rhododendron Dr @ Site Entrance																																																																																																																																																																																																																															
0	0	0	11																																																																																																																																																																																																																												
Ped	L	T	R																																																																																																																																																																																																																												
0	0	199	11																																																																																																																																																																																																																												
162																																																																																																																																																																																																																															
R	T	L	PED																																																																																																																																																																																																																												
2	0	67	95																																																																																																																																																																																																																												
Ped	0	0	0																																																																																																																																																																																																																												
L	0	0	0																																																																																																																																																																																																																												
T	0	0	0																																																																																																																																																																																																																												
R	0	0	0																																																																																																																																																																																																																												
1: Rhododendron Dr @ 35 St																																																																																																																																																																																																																															
0	0	0	52																																																																																																																																																																																																																												
Ped	L	T	R																																																																																																																																																																																																																												
0	0	70	52																																																																																																																																																																																																																												
108																																																																																																																																																																																																																															
122																																																																																																																																																																																																																															
465																																																																																																																																																																																																																															
2021 with pipeline trips																																																																																																																																																																																																																															
R	T	L	PED																																																																																																																																																																																																																												
0	2	159	207																																																																																																																																																																																																																												
Ped	0	0	0																																																																																																																																																																																																																												
L	0	158	1																																																																																																																																																																																																																												
T	0	0	0																																																																																																																																																																																																																												
R	0	0	0																																																																																																																																																																																																																												
2: Rhododendron Dr @ Site Entrance																																																																																																																																																																																																																															
0	0	0	15																																																																																																																																																																																																																												
Ped	L	T	R																																																																																																																																																																																																																												
0	0	204	15																																																																																																																																																																																																																												
184																																																																																																																																																																																																																															
219																																																																																																																																																																																																																															
407																																																																																																																																																																																																																															
239																																																																																																																																																																																																																															
R	T	L	PED																																																																																																																																																																																																																												
2	0	108	131																																																																																																																																																																																																																												
Ped	0	0	0																																																																																																																																																																																																																												
L	0	0	0																																																																																																																																																																																																																												
T	0	0	0																																																																																																																																																																																																																												
R	0	0	0																																																																																																																																																																																																																												
1: Rhododendron Dr @ 35 St																																																																																																																																																																																																																															
0	0	0	52																																																																																																																																																																																																																												
Ped	L	T	R																																																																																																																																																																																																																												
0	0	85	52																																																																																																																																																																																																																												
149																																																																																																																																																																																																																															
137																																																																																																																																																																																																																															
152																																																																																																																																																																																																																															
183																																																																																																																																																																																																																															
193																																																																																																																																																																																																																															

EDIT Highlighted		2022 AM Volumes Background																																																																																																																					
Base Year <input type="text" value="2021"/> Target Year <input type="text" value="2024"/> Years of Growth <input type="text" value="3"/> Growth Rate Per Year <input type="text" value="0.010"/> Growth Factor <input type="text" value="1.03"/>																																																																																																																							
<table border="1"> <tr><td colspan="4">2022 AM</td></tr> <tr><td>R</td><td>T</td><td>L</td><td>PED</td></tr> <tr><td>1</td><td>0</td><td>163</td><td>1</td></tr> <tr><td>Ped</td><td>0</td><td>0</td><td>0</td></tr> <tr><td>L</td><td>0</td><td>0</td><td>0</td></tr> <tr><td>T</td><td>0</td><td>0</td><td>0</td></tr> <tr><td>R</td><td>0</td><td>0</td><td>0</td></tr> <tr><td colspan="4">2: Rhododendron Dr @ Site Entrance</td></tr> <tr><td>0</td><td>0</td><td>0</td><td>16</td></tr> <tr><td>Ped</td><td>L</td><td>T</td><td>R</td></tr> <tr><td>0</td><td>0</td><td>210</td><td>16</td></tr> <tr><td colspan="4">189</td></tr> <tr><td colspan="4">226</td></tr> <tr><td colspan="4">246</td></tr> <tr><td>R</td><td>T</td><td>L</td><td>PED</td></tr> <tr><td>1</td><td>0</td><td>111</td><td>135</td></tr> <tr><td>Ped</td><td>0</td><td>0</td><td>0</td></tr> <tr><td>L</td><td>0</td><td>0</td><td>0</td></tr> <tr><td>T</td><td>0</td><td>0</td><td>0</td></tr> <tr><td>R</td><td>0</td><td>0</td><td>0</td></tr> <tr><td colspan="4">1: Rhododendron Dr @ 35 St</td></tr> <tr><td>0</td><td>0</td><td>0</td><td>54</td></tr> <tr><td>Ped</td><td>L</td><td>T</td><td>R</td></tr> <tr><td>0</td><td>0</td><td>88</td><td>54</td></tr> <tr><td colspan="4">153</td></tr> <tr><td colspan="4">141</td></tr> <tr><td colspan="4">157</td></tr> <tr><td colspan="4">188</td></tr> <tr><td colspan="4">199</td></tr> </table>		2022 AM				R	T	L	PED	1	0	163	1	Ped	0	0	0	L	0	0	0	T	0	0	0	R	0	0	0	2: Rhododendron Dr @ Site Entrance				0	0	0	16	Ped	L	T	R	0	0	210	16	189				226				246				R	T	L	PED	1	0	111	135	Ped	0	0	0	L	0	0	0	T	0	0	0	R	0	0	0	1: Rhododendron Dr @ 35 St				0	0	0	54	Ped	L	T	R	0	0	88	54	153				141				157				188				199					
2022 AM																																																																																																																							
R	T	L	PED																																																																																																																				
1	0	163	1																																																																																																																				
Ped	0	0	0																																																																																																																				
L	0	0	0																																																																																																																				
T	0	0	0																																																																																																																				
R	0	0	0																																																																																																																				
2: Rhododendron Dr @ Site Entrance																																																																																																																							
0	0	0	16																																																																																																																				
Ped	L	T	R																																																																																																																				
0	0	210	16																																																																																																																				
189																																																																																																																							
226																																																																																																																							
246																																																																																																																							
R	T	L	PED																																																																																																																				
1	0	111	135																																																																																																																				
Ped	0	0	0																																																																																																																				
L	0	0	0																																																																																																																				
T	0	0	0																																																																																																																				
R	0	0	0																																																																																																																				
1: Rhododendron Dr @ 35 St																																																																																																																							
0	0	0	54																																																																																																																				
Ped	L	T	R																																																																																																																				
0	0	88	54																																																																																																																				
153																																																																																																																							
141																																																																																																																							
157																																																																																																																							
188																																																																																																																							
199																																																																																																																							

EDIT Highlighted		2027 AM Volumes Background																																																																																																																					
Base Year <input type="text" value="2021"/> Target Year <input type="text" value="2029"/> Years of Growth <input type="text" value="8"/> Growth Rate Per Year <input type="text" value="0.010"/> Growth Factor <input type="text" value="1.08"/>																																																																																																																							
<table border="1"> <tr><td colspan="4">2027 AM</td></tr> <tr><td>R</td><td>T</td><td>L</td><td>PED</td></tr> <tr><td>1</td><td>0</td><td>171</td><td>1</td></tr> <tr><td>Ped</td><td>0</td><td>0</td><td>0</td></tr> <tr><td>L</td><td>0</td><td>0</td><td>0</td></tr> <tr><td>T</td><td>0</td><td>0</td><td>0</td></tr> <tr><td>R</td><td>0</td><td>0</td><td>0</td></tr> <tr><td colspan="4">2: Rhododendron Dr @ Site Entrance</td></tr> <tr><td>0</td><td>0</td><td>0</td><td>16</td></tr> <tr><td>Ped</td><td>L</td><td>T</td><td>R</td></tr> <tr><td>0</td><td>0</td><td>220</td><td>16</td></tr> <tr><td colspan="4">199</td></tr> <tr><td colspan="4">237</td></tr> <tr><td colspan="4">258</td></tr> <tr><td>R</td><td>T</td><td>L</td><td>PED</td></tr> <tr><td>1</td><td>0</td><td>117</td><td>141</td></tr> <tr><td>Ped</td><td>0</td><td>0</td><td>0</td></tr> <tr><td>L</td><td>0</td><td>0</td><td>0</td></tr> <tr><td>T</td><td>0</td><td>0</td><td>0</td></tr> <tr><td>R</td><td>0</td><td>0</td><td>0</td></tr> <tr><td colspan="4">1: Rhododendron Dr @ 35 St</td></tr> <tr><td>0</td><td>0</td><td>0</td><td>56</td></tr> <tr><td>Ped</td><td>L</td><td>T</td><td>R</td></tr> <tr><td>0</td><td>0</td><td>92</td><td>56</td></tr> <tr><td colspan="4">161</td></tr> <tr><td colspan="4">148</td></tr> <tr><td colspan="4">164</td></tr> <tr><td colspan="4">198</td></tr> <tr><td colspan="4">208</td></tr> </table>		2027 AM				R	T	L	PED	1	0	171	1	Ped	0	0	0	L	0	0	0	T	0	0	0	R	0	0	0	2: Rhododendron Dr @ Site Entrance				0	0	0	16	Ped	L	T	R	0	0	220	16	199				237				258				R	T	L	PED	1	0	117	141	Ped	0	0	0	L	0	0	0	T	0	0	0	R	0	0	0	1: Rhododendron Dr @ 35 St				0	0	0	56	Ped	L	T	R	0	0	92	56	161				148				164				198				208					
2027 AM																																																																																																																							
R	T	L	PED																																																																																																																				
1	0	171	1																																																																																																																				
Ped	0	0	0																																																																																																																				
L	0	0	0																																																																																																																				
T	0	0	0																																																																																																																				
R	0	0	0																																																																																																																				
2: Rhododendron Dr @ Site Entrance																																																																																																																							
0	0	0	16																																																																																																																				
Ped	L	T	R																																																																																																																				
0	0	220	16																																																																																																																				
199																																																																																																																							
237																																																																																																																							
258																																																																																																																							
R	T	L	PED																																																																																																																				
1	0	117	141																																																																																																																				
Ped	0	0	0																																																																																																																				
L	0	0	0																																																																																																																				
T	0	0	0																																																																																																																				
R	0	0	0																																																																																																																				
1: Rhododendron Dr @ 35 St																																																																																																																							
0	0	0	56																																																																																																																				
Ped	L	T	R																																																																																																																				
0	0	92	56																																																																																																																				
161																																																																																																																							
148																																																																																																																							
164																																																																																																																							
198																																																																																																																							
208																																																																																																																							

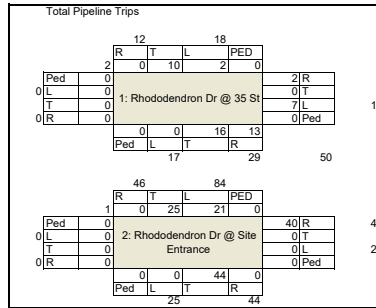
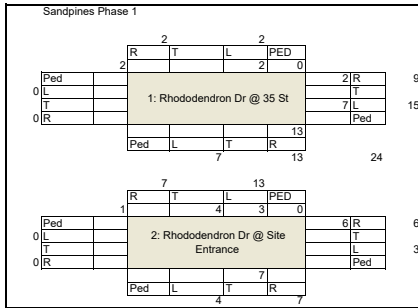

Sandpines Phase 1
 40 lots approved
 18 completed
 22

Fawn
 20

24 total
 15 in
 9 out

22 total
 14 in
 8 out

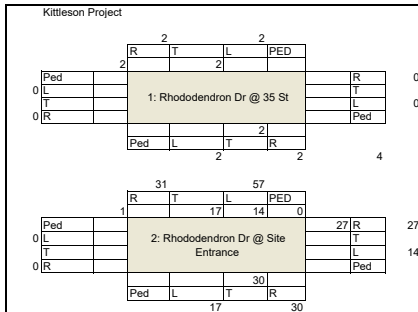
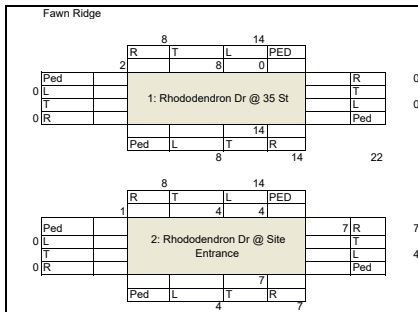

SEASONAL TREND TABLE (Updated: 7/20/2021) ¹																										Seasonal	
TREND	1-Jan	15-Jan	1-Feb	15-Feb	1-Mar	15-Mar	1-Apr	15-Apr	1-May	15-May	1-Jun	15-Jun	1-Jul	15-Jul	1-Aug	15-Aug	1-Sep	15-Sep	1-Oct	15-Oct	1-Nov	15-Nov	1-Dec	15-Dec	1-Dec	15-Dec	Trend Peak
INTERSTATE URBANIZED	1.0672	1.0684	1.0922	1.1160	1.0605	1.0050	0.9923	0.9796	0.9781	0.9767	0.9615	0.9463	0.9517	0.9571	0.9551	0.9531	0.9674	0.9816	0.9850	0.9884	1.0045	1.0206	1.0322	1.0438	0.9463	1.0438	0.9463
INTERSTATE NONURBANIZED	1.2426	1.2883	1.3750	1.4616	1.2645	1.0673	1.0382	1.0092	0.9798	0.9504	0.9005	0.8506	0.8322	0.8139	0.8221	0.8302	0.8719	0.9135	0.9441	0.9747	1.0178	1.0608	1.1123	1.1638	0.8139	1.1638	0.8139
COMMUTER	1.0850	1.0875	1.1183	1.1492	1.0880	1.0268	1.0014	0.9759	0.9705	0.9650	0.9503	0.9355	0.9470	0.9585	0.9509	0.9433	0.9528	0.9623	0.9614	0.9604	0.9938	1.0272	1.0474	1.0676	0.9355	1.0676	0.9355
COASTAL DESTINATION	1.1885	1.1712	1.2001	1.2289	1.1242	1.0194	1.0316	1.0437	1.0080	0.9723	0.9347	0.8972	0.8612	0.8252	0.8205	0.8159	0.8686	0.9214	0.9689	1.0164	1.0660	1.1156	1.1580	1.2005	0.8159	1.2005	0.8159
COASTAL DESTINATION ROUTE	1.3445	1.3248	1.4108	1.4968	1.2858	1.0747	1.0911	1.1076	1.0274	0.9473	0.8941	0.8409	0.7820	0.7231	0.7218	0.7205	0.8016	0.8827	0.9669	1.0511	1.1133	1.1754	1.2480	1.3206	0.7205	1.3206	0.7205
AGRICULTURE	1.4583	1.4827	1.5763	1.6700	1.4596	1.2492	1.1487	1.0482	0.9747	0.9011	0.8579	0.8146	0.8058	0.7970	0.7922	0.7772	0.7772	0.7670	0.8288	0.8905	0.9947	1.0989	1.2462	1.3934	0.7670	1.3934	0.7670
RECREATIONAL SUMMER	1.5848	1.6474	1.7861	1.9247	1.6595	1.3942	1.2973	1.2004	1.0517	0.9029	0.8256	0.7484	0.7018	0.6552	0.6708	0.6864	0.7393	0.7922	0.8898	0.9874	1.1242	1.2610	1.3965	1.5320	0.6552	1.5320	0.6552
RECREATIONAL SUMMER WINTER	0.8736	0.8525	0.9330	1.0135	1.0146	1.0158	1.1492	1.2825	1.1763	1.0700	0.9760	0.8821	0.8005	0.7190	0.7305	0.7420	0.8897	1.0374	1.2010	1.3645	1.5212	1.6778	1.8112	1.0847	1.7190	1.0847	0.7190
RECREATIONAL WINTER	0.6997	0.6389	0.6561	0.6733	0.7219	0.7704	1.0580	1.3455	1.3746	1.4058	1.2832	1.1625	0.9985	0.8344	0.8600	0.8857	1.0560	1.2262	1.4100	1.5937	1.8758	2.1580	1.5328	0.9076	2.1580	0.9076	0.6389
SUMMER	1.2151	1.2357	1.3129	1.3901	1.2520	1.1139	1.0620	1.0100	0.9718	0.9336	0.8976	0.8615	0.8457	0.8299	0.8354	0.8410	0.8743	0.9077	0.9357	0.9636	1.0273	1.0908	1.1322	1.1737	0.8299	1.1737	0.8299
SUMMER < 2500	1.3035	1.3186	1.3817	1.4448	1.2869	1.1289	1.0598	0.9906	0.9480	0.9053	0.8720	0.8387	0.8237	0.8086	0.8229	0.8373	0.8616	0.8859	0.9233	0.9607	1.0428	1.1249	1.2016	1.2783	0.8086	1.2783	0.8086

* Seasonal Trend Table factors are based on previous year ATR data. The table is updated yearly.
 * Grey shading indicates months were seasonal factor is greater than or less than 30%
 * February 2019 snow event causing lower seasonal factors

¹Seasonal Trend Table: The 2020 table is based on 2019 values due to the irregularity caused by the Covid epidemic shutdown during the 2020 count year.

15-Oct Peak
 Coastal Dest 1.0164 0.8159 1.245804
 1.245804
 1-Sep Peak
 Coastal Dest 0.8686 0.8159 1.064644
 1.064644

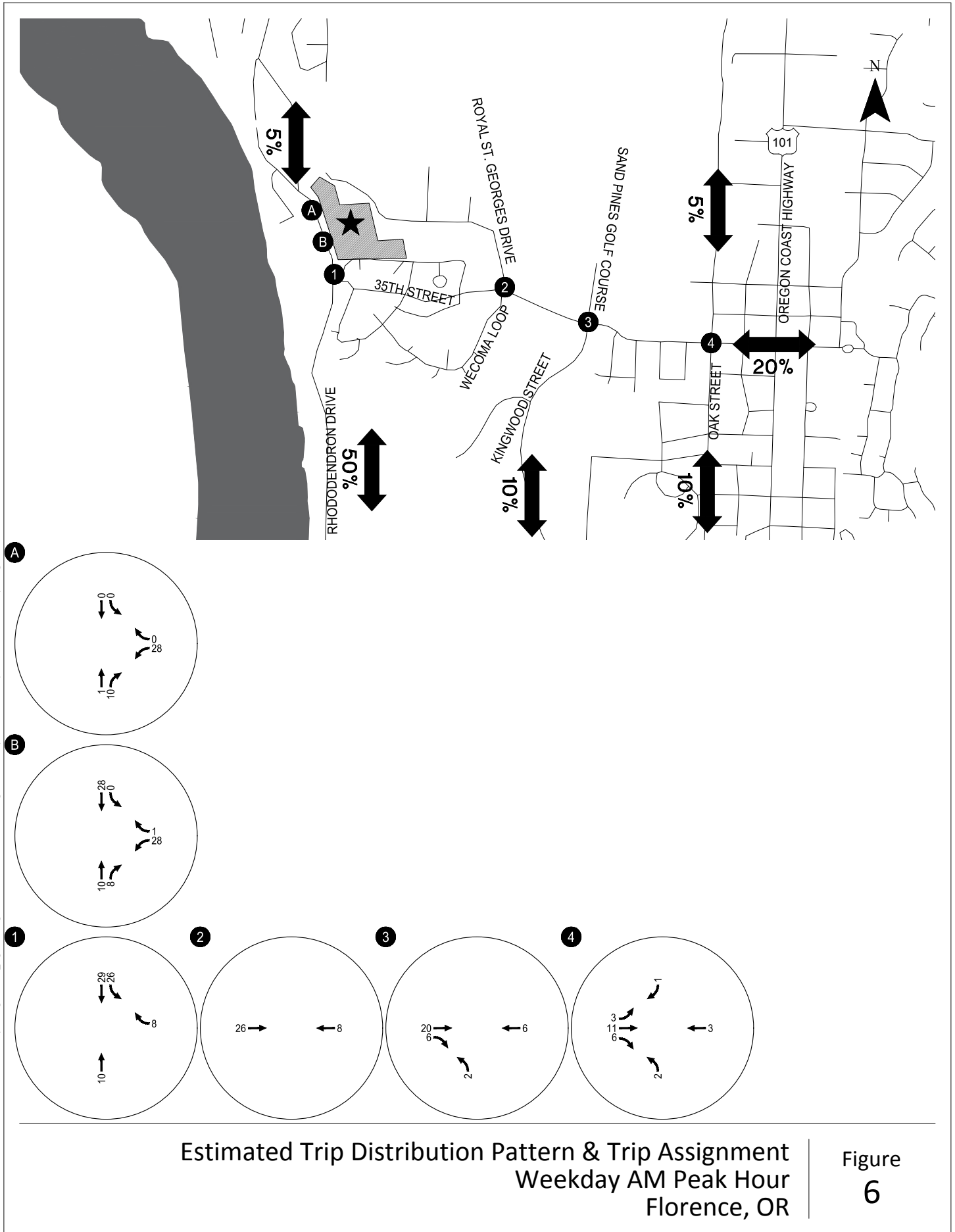

H:\2\24714 - Florence Residential Subdivision\report\figs\24714_Figures.dwg Feb 11, 2020 - 8:56am - agriffiths Layout Tab: AM Trip Distribution and Trip Assignment

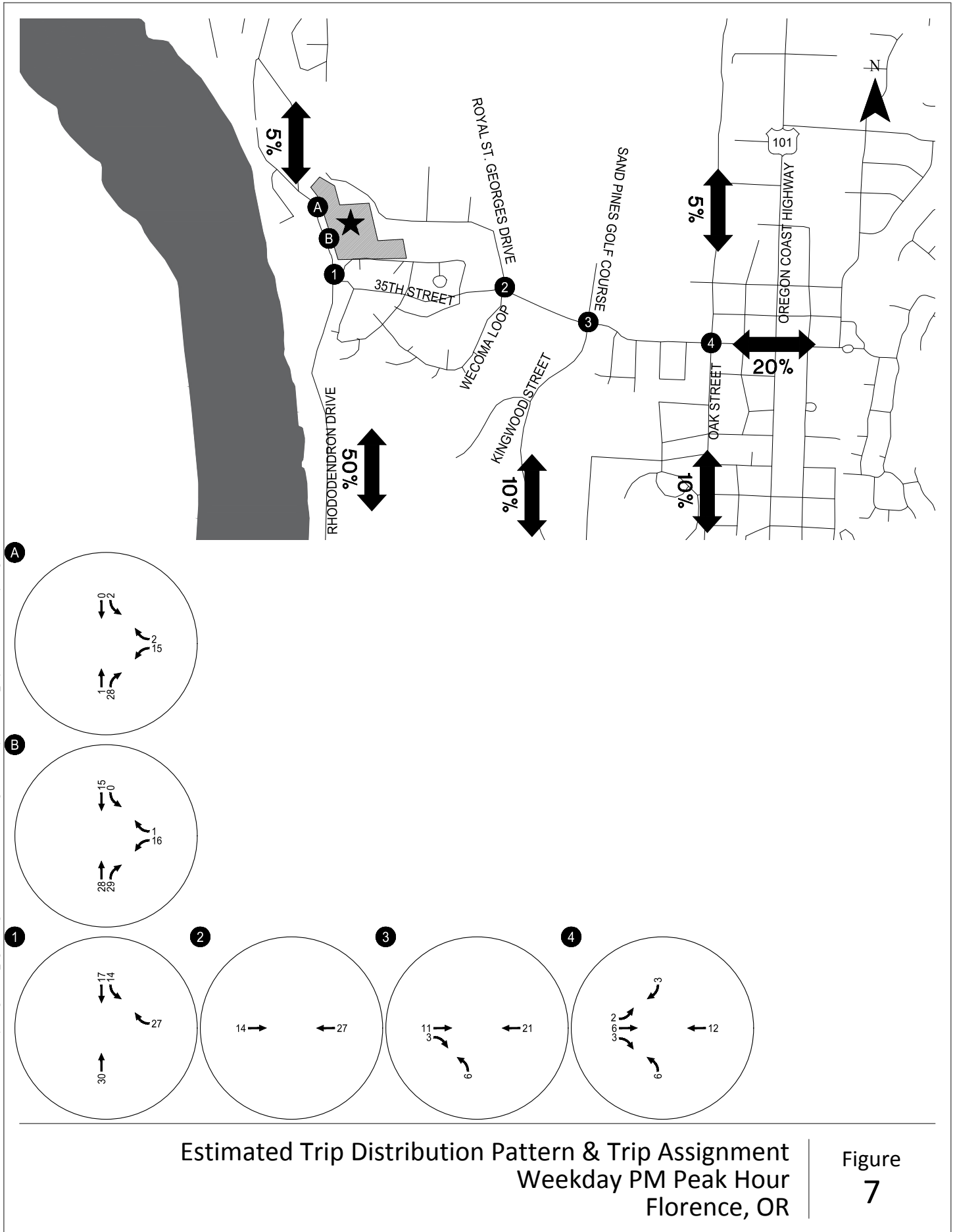

H:\2\24714 - Florence Residential Subdivision\report\figs\24714_Figures.dwg Feb 11, 2020 - 8:56am - agriffiths Layout Tab: PM_Trip Distribution and Trip Assignment

LOCATION: Rhododendron Dr -- 35th St
CITY/STATE: Florence, OR

QC JOB #: 15273704
DATE: Thu, Aug 27 2020

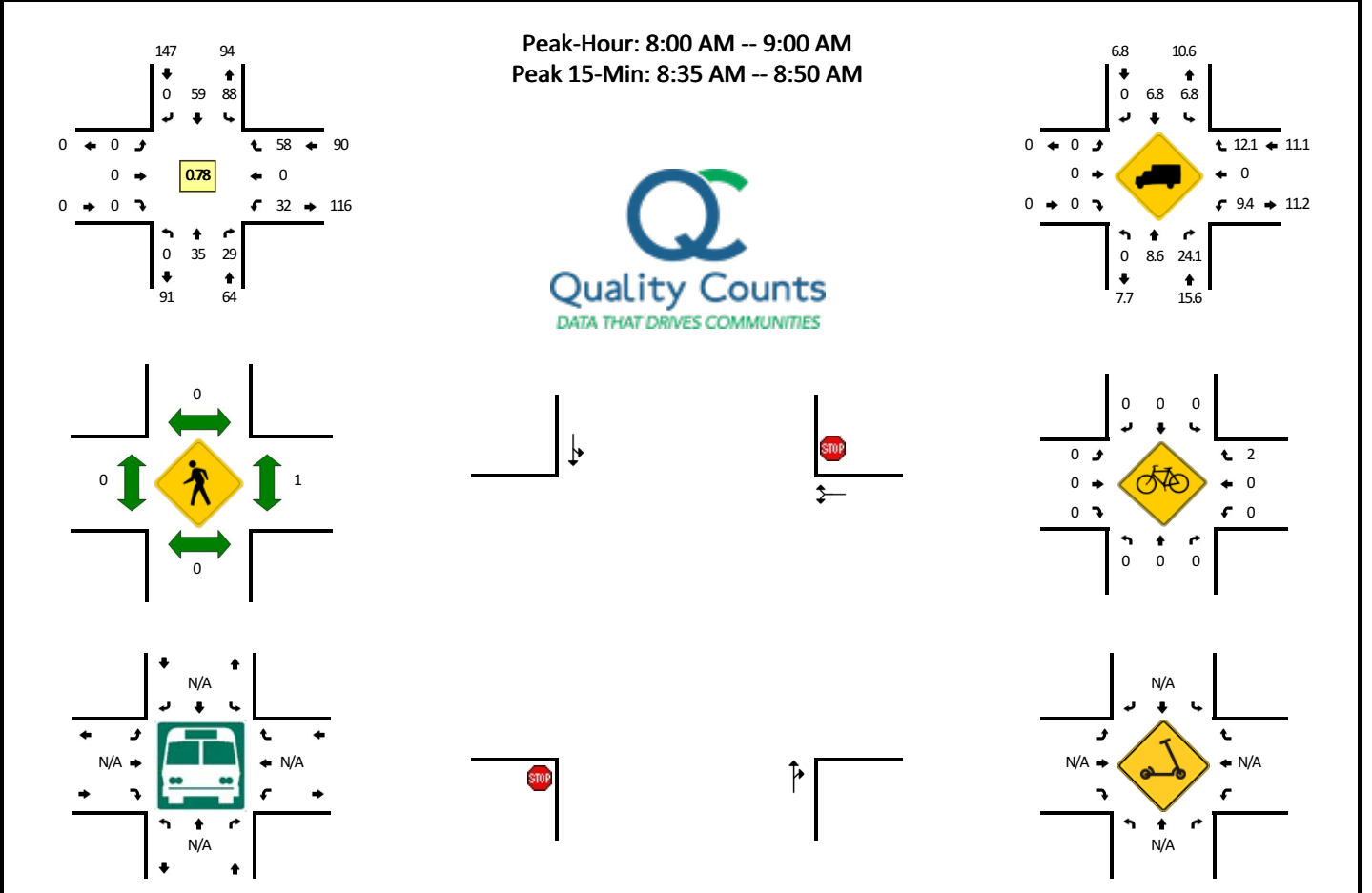

5-Min Count Period Beginning At	Rhododendron Dr (Northbound)				Rhododendron Dr (Southbound)				35th St (Eastbound)				35th St (Westbound)				Total	Hourly Totals
	Left	Thru	Right	U	Left	Thru	Right	U	Left	Thru	Right	U	Left	Thru	Right	U		
7:00 AM	0	2	1	0	3	1	0	0	0	0	0	0	1	0	7	0	15	
7:05 AM	0	0	1	0	4	1	0	0	0	0	0	0	2	0	1	0	9	
7:10 AM	0	1	0	0	3	2	0	0	0	0	0	0	1	0	4	0	11	
7:15 AM	0	2	0	0	8	2	0	0	0	0	0	0	3	0	2	0	17	
7:20 AM	0	1	2	0	1	2	0	0	0	0	0	0	1	0	4	0	11	
7:25 AM	0	4	0	0	7	4	0	0	0	0	0	0	0	0	3	0	18	
7:30 AM	0	0	1	0	2	2	0	0	0	0	0	0	2	0	3	0	10	
7:35 AM	0	1	3	0	8	6	0	0	0	0	0	0	1	0	6	0	25	
7:40 AM	0	1	1	0	9	6	0	0	0	0	0	0	0	0	3	0	20	
7:45 AM	0	2	2	0	4	6	0	0	0	0	0	0	4	0	5	0	23	
7:50 AM	0	2	2	0	9	3	0	0	0	0	0	0	1	0	6	0	23	
7:55 AM	0	4	3	0	6	6	0	0	0	0	0	0	1	0	3	0	23	205
8:00 AM	0	1	1	0	3	1	0	0	0	0	0	0	3	0	5	0	14	204
8:05 AM	0	2	0	0	3	4	0	0	0	0	0	0	2	0	6	0	17	212
8:10 AM	0	2	1	0	3	7	0	0	0	0	0	0	3	0	6	0	22	223
8:15 AM	0	3	3	0	11	4	0	0	0	0	0	0	2	0	3	0	26	232
8:20 AM	0	3	1	0	3	2	0	0	0	0	0	0	4	0	2	0	15	236
8:25 AM	0	5	1	0	8	4	0	1	0	0	0	0	2	0	7	0	28	246
8:30 AM	0	3	5	0	3	2	0	0	0	0	0	0	3	0	4	0	20	256
8:35 AM	0	2	3	0	17	5	0	0	0	0	0	0	1	0	9	0	37	268
8:40 AM	0	3	3	0	8	8	0	0	0	0	0	0	3	0	3	0	28	276
8:45 AM	0	2	3	0	11	9	0	0	0	0	0	0	4	0	3	0	32	285
8:50 AM	0	3	3	0	8	9	0	0	0	0	0	0	2	0	5	0	30	292
8:55 AM	0	6	5	0	9	4	0	0	0	0	0	0	3	0	5	0	32	301
Peak 15-Min Flowrates	Northbound				Southbound				Eastbound				Westbound				Total	
	Left	Thru	Right	U	Left	Thru	Right	U	Left	Thru	Right	U	Left	Thru	Right	U		
All Vehicles	0	28	36	0	144	88	0	0	0	0	0	0	32	0	60	0	388	
Heavy Trucks	0	0	0	0	12	8	0	0	0	0	0	0	4	0	4	0	28	
Buses																		
Pedestrians		0				0				0				0			0	
Bicycles	0	0	0		0	0	0			0	0	0	0	0	0		0	
Scoters																		

Comments:

LOCATION: Rhododendron Dr -- 35th St
CITY/STATE: Florence, OR

QC JOB #: 15273705
DATE: Thu, Aug 27 2020

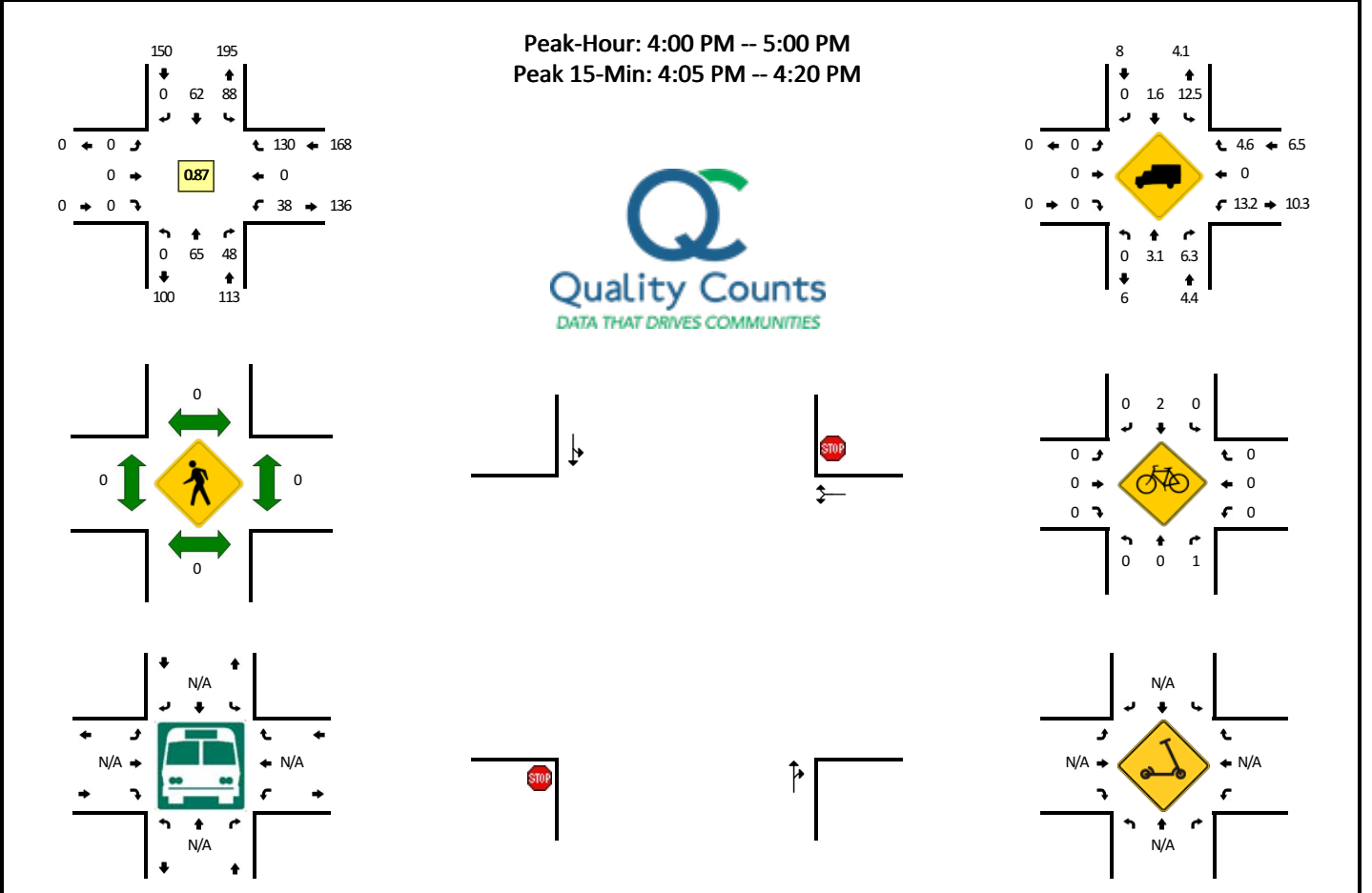

5-Min Count Period Beginning At	Rhododendron Dr (Northbound)				Rhododendron Dr (Southbound)				35th St (Eastbound)				35th St (Westbound)				Total	Hourly Totals
	Left	Thru	Right	U	Left	Thru	Right	U	Left	Thru	Right	U	Left	Thru	Right	U		
4:00 PM	0	6	11	0	6	4	0	0	0	0	0	0	1	0	9	0	37	
4:05 PM	0	6	3	0	8	9	0	0	0	0	0	0	6	0	13	0	45	
4:10 PM	0	6	3	0	6	5	0	0	0	0	0	0	4	0	11	0	35	
4:15 PM	0	7	3	0	12	9	0	0	0	0	0	0	1	0	12	0	44	
4:20 PM	0	2	2	0	11	6	0	0	0	0	0	0	2	0	11	0	34	
4:25 PM	0	5	8	0	7	2	0	0	0	0	0	0	2	0	5	0	29	
4:30 PM	0	4	2	0	5	4	0	0	0	0	0	0	6	0	9	0	30	
4:35 PM	0	5	8	0	8	7	0	0	0	0	0	0	4	0	15	0	47	
4:40 PM	0	7	3	0	5	6	0	0	0	0	0	0	4	0	8	0	33	
4:45 PM	0	4	2	0	7	6	0	0	0	0	0	0	3	0	9	0	31	
4:50 PM	0	3	3	0	8	4	0	0	0	0	0	0	3	0	12	0	33	
4:55 PM	0	10	0	0	5	0	0	0	0	0	0	0	2	0	16	0	33	431
5:00 PM	0	8	2	0	7	1	0	0	0	0	0	0	4	0	8	0	30	424
5:05 PM	0	3	3	0	5	5	0	0	0	0	0	0	2	0	12	0	30	409
5:10 PM	0	7	2	0	5	10	0	0	0	0	0	0	4	0	13	0	41	415
5:15 PM	0	7	2	0	9	9	0	0	0	0	0	0	0	0	8	0	35	406
5:20 PM	0	5	1	0	2	4	0	0	0	0	0	0	5	0	10	0	27	399
5:25 PM	0	6	2	0	7	5	0	0	0	0	0	0	3	0	8	0	31	401
5:30 PM	0	1	0	0	4	2	0	0	0	0	0	0	4	0	5	0	16	387
5:35 PM	0	4	0	0	5	1	0	0	0	0	0	0	0	0	10	0	20	360
5:40 PM	0	2	2	0	0	3	0	0	0	0	0	0	1	0	9	0	17	344
5:45 PM	0	3	3	0	4	5	0	0	0	0	0	0	0	0	5	0	20	333
5:50 PM	0	3	1	0	5	8	0	0	0	0	0	0	0	0	9	0	26	326
5:55 PM	0	1	0	0	5	5	0	0	0	0	0	0	0	0	8	0	19	312
Peak 15-Min Flowrates	Northbound				Southbound				Eastbound				Westbound				Total	
	Left	Thru	Right	U	Left	Thru	Right	U	Left	Thru	Right	U	Left	Thru	Right	U		
All Vehicles	0	76	36	0	104	92	0	0	0	0	0	0	44	0	144	0	496	
Heavy Trucks	0	4	8	0	20	0	0	0	0	0	0	0	8	0	4	0	44	
Buses																		
Pedestrians		0				0					0			0			0	
Bicycles	0	0	0		0	8	0			0	0	0	0	0	0		8	
Scoters																		

Comments:

Fairway Estates

HCM 6th TWSC
3: Rhododendron & tournament

01/05/2022

Intersection						
Int Delay, s/veh	0.7					
Movement	WBL	WBR	NBT	NBR	SBL	SBT
Lane Configurations	TT		TT			TT
Traffic Vol, veh/h	15	4	102	8	2	174
Future Vol, veh/h	15	4	102	8	2	174
Conflicting Peds, #/hr	0	0	0	0	0	0
Sign Control	Stop	Stop	Free	Free	Free	Free
RT Channelized	-	None	-	None	-	None
Storage Length	0	-	-	-	-	-
Veh in Median Storage, #	0	-	0	-	-	0
Grade, %	0	-	0	-	-	0
Peak Hour Factor	90	90	90	90	90	90
Heavy Vehicles, %	0	0	4	0	4	0
Mvmt Flow	17	4	113	9	2	193

Major/Minor	Minor1	Major1	Major2			
Conflicting Flow All	315	118	0	0	122	0
Stage 1	118	-	-	-	-	-
Stage 2	197	-	-	-	-	-
Critical Hdwy	6.4	6.2	-	-	4.14	-
Critical Hdwy Stg 1	5.4	-	-	-	-	-
Critical Hdwy Stg 2	5.4	-	-	-	-	-
Follow-up Hdwy	3.5	3.3	-	-	2.236	-
Pot Cap-1 Maneuver	682	939	-	-	1453	-
Stage 1	912	-	-	-	-	-
Stage 2	841	-	-	-	-	-
Platoon blocked, %			-	-		-
Mov Cap-1 Maneuver	681	939	-	-	1453	-
Mov Cap-2 Maneuver	681	-	-	-	-	-
Stage 1	912	-	-	-	-	-
Stage 2	839	-	-	-	-	-

Approach	WB	NB	SB
HCM Control Delay, s	10.1	0	0.1
HCM LOS	B		

Minor Lane/Major Mvmt	NBT	NBRWBLn1	SBL	SBT
Capacity (veh/h)	-	-	723	1453
HCM Lane V/C Ratio	-	-	0.029	0.002
HCM Control Delay (s)	-	-	10.1	7.5
HCM Lane LOS	-	-	B	A
HCM 95th %tile Q(veh)	-	-	0.1	0

Intersection						
Int Delay, s/veh	5.4					
Movement	WBL	WBR	NBT	NBR	SBL	SBT
Lane Configurations						
Traffic Vol, veh/h	34	75	53	31	136	108
Future Vol, veh/h	34	75	53	31	136	108
Conflicting Peds, #/hr	0	0	0	0	0	0
Sign Control	Stop	Stop	Free	Free	Free	Free
RT Channelized	-	None	-	None	-	None
Storage Length	0	-	-	-	-	-
Veh in Median Storage, #	0	-	0	-	-	0
Grade, %	0	-	0	-	-	0
Peak Hour Factor	80	80	80	80	80	80
Heavy Vehicles, %	13	7	0	0	14	14
Mvmt Flow	43	94	66	39	170	135

Major/Minor	Minor1	Major1	Major2		
Conflicting Flow All	561	86	0	0	105
Stage 1	86	-	-	-	-
Stage 2	475	-	-	-	-
Critical Hdwy	6.53	6.27	-	-	4.24
Critical Hdwy Stg 1	5.53	-	-	-	-
Critical Hdwy Stg 2	5.53	-	-	-	-
Follow-up Hdwy	3.617	3.363	-	-	2.326
Pot Cap-1 Maneuver	471	959	-	-	1415
Stage 1	910	-	-	-	-
Stage 2	603	-	-	-	-
Platoon blocked, %			-	-	-
Mov Cap-1 Maneuver	410	959	-	-	1415
Mov Cap-2 Maneuver	410	-	-	-	-
Stage 1	910	-	-	-	-
Stage 2	525	-	-	-	-

Approach	WB	NB	SB
HCM Control Delay, s	11.7	0	4.4
HCM LOS	B		

Minor Lane/Major Mvmt	NBT	NBRWBLn1	SBL	SBT
Capacity (veh/h)	-	-	676	1415
HCM Lane V/C Ratio	-	-	0.202	0.12
HCM Control Delay (s)	-	-	11.7	7.9
HCM Lane LOS	-	-	B	A
HCM 95th %tile Q(veh)	-	-	0.7	0.4

HCM 6th TWSC
3: Rhododendron & tournament

01/06/2022

Intersection						
Int Delay, s/veh	0.8					
Movement	WBL	WBR	NBT	NBR	SBL	SBT
Lane Configurations						
Traffic Vol, veh/h	26	3	204	15	1	158
Future Vol, veh/h	26	3	204	15	1	158
Conflicting Peds, #/hr	0	0	0	0	0	0
Sign Control	Stop	Stop	Free	Free	Free	Free
RT Channelized	-	None	-	None	-	None
Storage Length	0	-	-	-	-	-
Veh in Median Storage, #	0	-	0	-	-	0
Grade, %	0	-	0	-	-	0
Peak Hour Factor	90	90	90	90	90	90
Heavy Vehicles, %	17	0	0	0	0	1
Mvmt Flow	29	3	227	17	1	176

Major/Minor	Minor1	Major1	Major2		
Conflicting Flow All	414	236	0	0	244
Stage 1	236	-	-	-	-
Stage 2	178	-	-	-	-
Critical Hdwy	6.57	6.2	-	-	4.1
Critical Hdwy Stg 1	5.57	-	-	-	-
Critical Hdwy Stg 2	5.57	-	-	-	-
Follow-up Hdwy	3.653	3.3	-	-	2.2
Pot Cap-1 Maneuver	567	808	-	-	1334
Stage 1	769	-	-	-	-
Stage 2	818	-	-	-	-
Platoon blocked, %			-	-	-
Mov Cap-1 Maneuver	566	808	-	-	1334
Mov Cap-2 Maneuver	566	-	-	-	-
Stage 1	769	-	-	-	-
Stage 2	817	-	-	-	-

Approach	WB	NB	SB
HCM Control Delay, s	11.5	0	0
HCM LOS	B		

Minor Lane/Major Mvmt	NBT	NBRWBLn1	SBL	SBT
Capacity (veh/h)	-	-	584	1334
HCM Lane V/C Ratio	-	-	0.055	0.001
HCM Control Delay (s)	-	-	11.5	7.7
HCM Lane LOS	-	-	B	A
HCM 95th %tile Q(veh)	-	-	0.2	0

Intersection						
Int Delay, s/veh	5.8					
Movement	WBL	WBR	NBT	NBR	SBL	SBT
Lane Configurations						
Traffic Vol, veh/h	41	152	85	52	131	108
Future Vol, veh/h	41	152	85	52	131	108
Conflicting Peds, #/hr	0	0	0	0	0	0
Sign Control	Stop	Stop	Free	Free	Free	Free
RT Channelized	-	None	-	None	-	None
Storage Length	0	-	-	-	-	-
Veh in Median Storage, #	0	-	0	-	-	0
Grade, %	0	-	0	-	-	0
Peak Hour Factor	92	92	92	92	92	92
Heavy Vehicles, %	21	3	6	17	23	0
Mvmt Flow	45	165	92	57	142	117

Major/Minor	Minor1	Major1	Major2		
Conflicting Flow All	522	121	0	0	149
Stage 1	121	-	-	-	-
Stage 2	401	-	-	-	-
Critical Hdwy	6.61	6.23	-	-	4.33
Critical Hdwy Stg 1	5.61	-	-	-	-
Critical Hdwy Stg 2	5.61	-	-	-	-
Follow-up Hdwy	3.689	3.327	-	-	2.407
Pot Cap-1 Maneuver	483	928	-	-	1314
Stage 1	859	-	-	-	-
Stage 2	637	-	-	-	-
Platoon blocked, %			-	-	-
Mov Cap-1 Maneuver	427	928	-	-	1314
Mov Cap-2 Maneuver	427	-	-	-	-
Stage 1	859	-	-	-	-
Stage 2	563	-	-	-	-

Approach	WB	NB	SB
HCM Control Delay, s	11.7	0	4.4
HCM LOS	B		

Minor Lane/Major Mvmt	NBT	NBRWBLn1	SBL	SBT
Capacity (veh/h)	-	-	743	1314
HCM Lane V/C Ratio	-	-	0.282	0.108
HCM Control Delay (s)	-	-	11.7	8.1
HCM Lane LOS	-	-	B	A
HCM 95th %tile Q(veh)	-	-	1.2	0.4

HCM 6th TWSC
 3: Rhododendron & tournament

01/05/2022

Intersection						
Int Delay, s/veh	0.7					
Movement	WBL	WBR	NBT	NBR	SBL	SBT
Lane Configurations	W		T			T
Traffic Vol, veh/h	15	4	105	8	2	179
Future Vol, veh/h	15	4	105	8	2	179
Conflicting Peds, #/hr	0	0	0	0	0	0
Sign Control	Stop	Stop	Free	Free	Free	Free
RT Channelized	-	None	-	None	-	None
Storage Length	0	-	-	-	-	-
Veh in Median Storage, #	0	-	0	-	-	0
Grade, %	0	-	0	-	-	0
Peak Hour Factor	90	90	90	90	90	90
Heavy Vehicles, %	0	0	4	0	4	0
Mvmt Flow	17	4	117	9	2	199

Major/Minor	Minor1	Major1	Major2			
Conflicting Flow All	325	122	0	0	126	0
Stage 1	122	-	-	-	-	-
Stage 2	203	-	-	-	-	-
Critical Hdwy	6.4	6.2	-	-	4.14	-
Critical Hdwy Stg 1	5.4	-	-	-	-	-
Critical Hdwy Stg 2	5.4	-	-	-	-	-
Follow-up Hdwy	3.5	3.3	-	-	2.236	-
Pot Cap-1 Maneuver	673	935	-	-	1448	-
Stage 1	908	-	-	-	-	-
Stage 2	836	-	-	-	-	-
Platoon blocked, %			-	-		-
Mov Cap-1 Maneuver	672	935	-	-	1448	-
Mov Cap-2 Maneuver	672	-	-	-	-	-
Stage 1	908	-	-	-	-	-
Stage 2	834	-	-	-	-	-

Approach	WB	NB	SB
HCM Control Delay, s	10.2	0	0.1
HCM LOS	B		

Minor Lane/Major Mvmt	NBT	NBRWBLn1	SBL	SBT
Capacity (veh/h)	-	-	714	1448
HCM Lane V/C Ratio	-	-	0.03	0.002
HCM Control Delay (s)	-	-	10.2	7.5
HCM Lane LOS	-	-	B	A
HCM 95th %tile Q(veh)	-	-	0.1	0

Intersection						
Int Delay, s/veh	5.4					
Movement	WBL	WBR	NBT	NBR	SBL	SBT
Lane Configurations						
Traffic Vol, veh/h	35	77	55	32	140	111
Future Vol, veh/h	35	77	55	32	140	111
Conflicting Peds, #/hr	0	0	0	0	0	0
Sign Control	Stop	Stop	Free	Free	Free	Free
RT Channelized	-	None	-	None	-	None
Storage Length	0	-	-	-	-	-
Veh in Median Storage, #	0	-	0	-	-	0
Grade, %	0	-	0	-	-	0
Peak Hour Factor	80	80	80	80	80	80
Heavy Vehicles, %	13	7	0	0	14	14
Mvmt Flow	44	96	69	40	175	139

Major/Minor	Minor1	Major1	Major2		
Conflicting Flow All	578	89	0	0	109
Stage 1	89	-	-	-	-
Stage 2	489	-	-	-	-
Critical Hdwy	6.53	6.27	-	-	4.24
Critical Hdwy Stg 1	5.53	-	-	-	-
Critical Hdwy Stg 2	5.53	-	-	-	-
Follow-up Hdwy	3.617	3.363	-	-	2.326
Pot Cap-1 Maneuver	460	955	-	-	1410
Stage 1	908	-	-	-	-
Stage 2	594	-	-	-	-
Platoon blocked, %			-	-	-
Mov Cap-1 Maneuver	398	955	-	-	1410
Mov Cap-2 Maneuver	398	-	-	-	-
Stage 1	908	-	-	-	-
Stage 2	514	-	-	-	-

Approach	WB	NB	SB
HCM Control Delay, s	11.9	0	4.4
HCM LOS	B		

Minor Lane/Major Mvmt	NBT	NBRWBLn1	SBL	SBT
Capacity (veh/h)	-	-	664	1410
HCM Lane V/C Ratio	-	-	0.211	0.124
HCM Control Delay (s)	-	-	11.9	7.9
HCM Lane LOS	-	-	B	A
HCM 95th %tile Q(veh)	-	-	0.8	0.4

HCM 6th TWSC
3: Rhododendron & tournament

01/06/2022

Intersection						
Int Delay, s/veh	0.8					
Movement	WBL	WBR	NBT	NBR	SBL	SBT
Lane Configurations						
Traffic Vol, veh/h	27	3	210	16	1	163
Future Vol, veh/h	27	3	210	16	1	163
Conflicting Peds, #/hr	0	0	0	0	0	0
Sign Control	Stop	Stop	Free	Free	Free	Free
RT Channelized	-	None	-	None	-	None
Storage Length	0	-	-	-	-	-
Veh in Median Storage, #	0	-	0	-	-	0
Grade, %	0	-	0	-	-	0
Peak Hour Factor	90	90	90	90	90	90
Heavy Vehicles, %	17	0	0	0	0	1
Mvmt Flow	30	3	233	18	1	181

Major/Minor	Minor1	Major1	Major2			
Conflicting Flow All	425	242	0	0	251	0
Stage 1	242	-	-	-	-	-
Stage 2	183	-	-	-	-	-
Critical Hdwy	6.57	6.2	-	-	4.1	-
Critical Hdwy Stg 1	5.57	-	-	-	-	-
Critical Hdwy Stg 2	5.57	-	-	-	-	-
Follow-up Hdwy	3.653	3.3	-	-	2.2	-
Pot Cap-1 Maneuver	559	802	-	-	1326	-
Stage 1	764	-	-	-	-	-
Stage 2	814	-	-	-	-	-
Platoon blocked, %			-	-		-
Mov Cap-1 Maneuver	558	802	-	-	1326	-
Mov Cap-2 Maneuver	558	-	-	-	-	-
Stage 1	764	-	-	-	-	-
Stage 2	813	-	-	-	-	-

Approach	WB	NB	SB
HCM Control Delay, s	11.6	0	0
HCM LOS	B		

Minor Lane/Major Mvmt	NBT	NBRWBLn1	SBL	SBT
Capacity (veh/h)	-	-	576	1326
HCM Lane V/C Ratio	-	-	0.058	0.001
HCM Control Delay (s)	-	-	11.6	7.7
HCM Lane LOS	-	-	B	A
HCM 95th %tile Q(veh)	-	-	0.2	0

Intersection						
Int Delay, s/veh	5.9					
Movement	WBL	WBR	NBT	NBR	SBL	SBT
Lane Configurations						
Traffic Vol, veh/h	42	157	88	54	135	111
Future Vol, veh/h	42	157	88	54	135	111
Conflicting Peds, #/hr	0	0	0	0	0	0
Sign Control	Stop	Stop	Free	Free	Free	Free
RT Channelized	-	None	-	None	-	None
Storage Length	0	-	-	-	-	-
Veh in Median Storage, #	0	-	0	-	-	0
Grade, %	0	-	0	-	-	0
Peak Hour Factor	92	92	92	92	92	92
Heavy Vehicles, %	21	3	6	17	23	0
Mvmt Flow	46	171	96	59	147	121

Major/Minor	Minor1	Major1	Major2		
Conflicting Flow All	541	126	0	0	155
Stage 1	126	-	-	-	-
Stage 2	415	-	-	-	-
Critical Hdwy	6.61	6.23	-	-	4.33
Critical Hdwy Stg 1	5.61	-	-	-	-
Critical Hdwy Stg 2	5.61	-	-	-	-
Follow-up Hdwy	3.689	3.327	-	-	2.407
Pot Cap-1 Maneuver	471	922	-	-	1307
Stage 1	855	-	-	-	-
Stage 2	627	-	-	-	-
Platoon blocked, %			-	-	-
Mov Cap-1 Maneuver	414	922	-	-	1307
Mov Cap-2 Maneuver	414	-	-	-	-
Stage 1	855	-	-	-	-
Stage 2	551	-	-	-	-

Approach	WB	NB	SB
HCM Control Delay, s	12	0	4.4
HCM LOS	B		

Minor Lane/Major Mvmt	NBT	NBRWBLn1	SBL	SBT
Capacity (veh/h)	-	-	732	1307
HCM Lane V/C Ratio	-	-	0.295	0.112
HCM Control Delay (s)	-	-	12	8.1
HCM Lane LOS	-	-	B	A
HCM 95th %tile Q(veh)	-	-	1.2	0.4

HCM 6th TWSC
3: Rhododendron & tournament

01/05/2022

Intersection						
Int Delay, s/veh	1.4					
Movement	WBL	WBR	NBT	NBR	SBL	SBT
Lane Configurations						
Traffic Vol, veh/h	39	5	105	16	3	179
Future Vol, veh/h	39	5	105	16	3	179
Conflicting Peds, #/hr	0	0	0	0	0	0
Sign Control	Stop	Stop	Free	Free	Free	Free
RT Channelized	-	None	-	None	-	None
Storage Length	0	-	-	-	-	-
Veh in Median Storage, #	0	-	0	-	-	0
Grade, %	0	-	0	-	-	0
Peak Hour Factor	90	90	90	90	90	90
Heavy Vehicles, %	0	0	4	0	4	0
Mvmt Flow	43	6	117	18	3	199

Major/Minor	Minor1	Major1	Major2		
Conflicting Flow All	331	126	0	0	135
Stage 1	126	-	-	-	-
Stage 2	205	-	-	-	-
Critical Hdwy	6.4	6.2	-	-	4.14
Critical Hdwy Stg 1	5.4	-	-	-	-
Critical Hdwy Stg 2	5.4	-	-	-	-
Follow-up Hdwy	3.5	3.3	-	-	2.236
Pot Cap-1 Maneuver	668	930	-	-	1437
Stage 1	905	-	-	-	-
Stage 2	834	-	-	-	-
Platoon blocked, %			-	-	-
Mov Cap-1 Maneuver	667	930	-	-	1437
Mov Cap-2 Maneuver	667	-	-	-	-
Stage 1	905	-	-	-	-
Stage 2	832	-	-	-	-

Approach	WB	NB	SB
HCM Control Delay, s	10.6	0	0.1
HCM LOS	B		

Minor Lane/Major Mvmt	NBT	NBRWBLn1	SBL	SBT
Capacity (veh/h)	-	-	689	1437
HCM Lane V/C Ratio	-	-	0.071	0.002
HCM Control Delay (s)	-	-	10.6	7.5
HCM Lane LOS	-	-	B	A
HCM 95th %tile Q(veh)	-	-	0.2	0

Intersection						
Int Delay, s/veh	5.5					
Movement	WBL	WBR	NBT	NBR	SBL	SBT
Lane Configurations						
Traffic Vol, veh/h	35	81	59	32	152	123
Future Vol, veh/h	35	81	59	32	152	123
Conflicting Peds, #/hr	0	0	0	0	0	0
Sign Control	Stop	Stop	Free	Free	Free	Free
RT Channelized	-	None	-	None	-	None
Storage Length	0	-	-	-	-	-
Veh in Median Storage, #	0	-	0	-	-	0
Grade, %	0	-	0	-	-	0
Peak Hour Factor	80	80	80	80	80	80
Heavy Vehicles, %	13	7	0	0	14	14
Mvmt Flow	44	101	74	40	190	154

Major/Minor	Minor1	Major1	Major2		
Conflicting Flow All	628	94	0	0	114
Stage 1	94	-	-	-	-
Stage 2	534	-	-	-	-
Critical Hdwy	6.53	6.27	-	-	4.24
Critical Hdwy Stg 1	5.53	-	-	-	-
Critical Hdwy Stg 2	5.53	-	-	-	-
Follow-up Hdwy	3.617	3.363	-	-	2.326
Pot Cap-1 Maneuver	430	949	-	-	1404
Stage 1	903	-	-	-	-
Stage 2	566	-	-	-	-
Platoon blocked, %			-	-	-
Mov Cap-1 Maneuver	366	949	-	-	1404
Mov Cap-2 Maneuver	366	-	-	-	-
Stage 1	903	-	-	-	-
Stage 2	482	-	-	-	-

Approach	WB	NB	SB
HCM Control Delay, s	12.3	0	4.4
HCM LOS	B		

Minor Lane/Major Mvmt	NBT	NBRWBLn1	SBL	SBT
Capacity (veh/h)	-	-	641	1404
HCM Lane V/C Ratio	-	-	0.226	0.135
HCM Control Delay (s)	-	-	12.3	8
HCM Lane LOS	-	-	B	A
HCM 95th %tile Q(veh)	-	-	0.9	0.5

HCM 6th TWSC
3: Rhododendron & tournament

01/06/2022

Intersection						
Int Delay, s/veh	1.2					
Movement	WBL	WBR	NBT	NBR	SBL	SBT
Lane Configurations						
Traffic Vol, veh/h	42	4	210	42	3	163
Future Vol, veh/h	42	4	210	42	3	163
Conflicting Peds, #/hr	0	0	0	0	0	0
Sign Control	Stop	Stop	Free	Free	Free	Free
RT Channelized	-	None	-	None	-	None
Storage Length	0	-	-	-	-	-
Veh in Median Storage, #	0	-	0	-	-	0
Grade, %	0	-	0	-	-	0
Peak Hour Factor	90	90	90	90	90	90
Heavy Vehicles, %	17	0	0	0	0	1
Mvmt Flow	47	4	233	47	3	181

Major/Minor	Minor1	Major1	Major2		
Conflicting Flow All	444	257	0	0	280
Stage 1	257	-	-	-	-
Stage 2	187	-	-	-	-
Critical Hdwy	6.57	6.2	-	-	4.1
Critical Hdwy Stg 1	5.57	-	-	-	-
Critical Hdwy Stg 2	5.57	-	-	-	-
Follow-up Hdwy	3.653	3.3	-	-	2.2
Pot Cap-1 Maneuver	544	787	-	-	1294
Stage 1	752	-	-	-	-
Stage 2	810	-	-	-	-
Platoon blocked, %			-	-	-
Mov Cap-1 Maneuver	542	787	-	-	1294
Mov Cap-2 Maneuver	542	-	-	-	-
Stage 1	752	-	-	-	-
Stage 2	808	-	-	-	-

Approach	WB	NB	SB
HCM Control Delay, s	12.1	0	0.1
HCM LOS	B		

Minor Lane/Major Mvmt	NBT	NBRWBLn1	SBL	SBT
Capacity (veh/h)	-	-	557	1294
HCM Lane V/C Ratio	-	-	0.092	0.003
HCM Control Delay (s)	-	-	12.1	7.8
HCM Lane LOS	-	-	B	A
HCM 95th %tile Q(veh)	-	-	0.3	0

Intersection						
Int Delay, s/veh	6					
Movement	WBL	WBR	NBT	NBR	SBL	SBT
Lane Configurations						
Traffic Vol, veh/h	42	170	101	54	142	119
Future Vol, veh/h	42	170	101	54	142	119
Conflicting Peds, #/hr	0	0	0	0	0	0
Sign Control	Stop	Stop	Free	Free	Free	Free
RT Channelized	-	None	-	None	-	None
Storage Length	0	-	-	-	-	-
Veh in Median Storage, #	0	-	0	-	-	0
Grade, %	0	-	0	-	-	0
Peak Hour Factor	92	92	92	92	92	92
Heavy Vehicles, %	21	3	6	17	23	0
Mvmt Flow	46	185	110	59	154	129

Major/Minor	Minor1	Major1	Major2		
Conflicting Flow All	577	140	0	0	169
Stage 1	140	-	-	-	-
Stage 2	437	-	-	-	-
Critical Hdwy	6.61	6.23	-	-	4.33
Critical Hdwy Stg 1	5.61	-	-	-	-
Critical Hdwy Stg 2	5.61	-	-	-	-
Follow-up Hdwy	3.689	3.327	-	-	2.407
Pot Cap-1 Maneuver	448	905	-	-	1291
Stage 1	842	-	-	-	-
Stage 2	613	-	-	-	-
Platoon blocked, %			-	-	-
Mov Cap-1 Maneuver	390	905	-	-	1291
Mov Cap-2 Maneuver	390	-	-	-	-
Stage 1	842	-	-	-	-
Stage 2	534	-	-	-	-

Approach	WB	NB	SB
HCM Control Delay, s	12.4	0	4.4
HCM LOS	B		

Minor Lane/Major Mvmt	NBT	NBRWBLn1	SBL	SBT
Capacity (veh/h)	-	-	717	1291
HCM Lane V/C Ratio	-	-	0.321	0.12
HCM Control Delay (s)	-	-	12.4	8.2
HCM Lane LOS	-	-	B	A
HCM 95th %tile Q(veh)	-	-	1.4	0.4

HCM 6th TWSC
3: Rhododendron & tournament

01/06/2022

Intersection						
Int Delay, s/veh	0.7					
Movement	WBL	WBR	NBT	NBR	SBL	SBT
Lane Configurations						
Traffic Vol, veh/h	16	5	110	8	2	188
Future Vol, veh/h	16	5	110	8	2	188
Conflicting Peds, #/hr	0	0	0	0	0	0
Sign Control	Stop	Stop	Free	Free	Free	Free
RT Channelized	-	None	-	None	-	None
Storage Length	0	-	-	-	-	-
Veh in Median Storage, #	0	-	0	-	-	0
Grade, %	0	-	0	-	-	0
Peak Hour Factor	90	90	90	90	90	90
Heavy Vehicles, %	0	0	4	0	4	0
Mvmt Flow	18	6	122	9	2	209

Major/Minor	Minor1	Major1	Major2		
Conflicting Flow All	340	127	0	0	131
Stage 1	127	-	-	-	-
Stage 2	213	-	-	-	-
Critical Hdwy	6.4	6.2	-	-	4.14
Critical Hdwy Stg 1	5.4	-	-	-	-
Critical Hdwy Stg 2	5.4	-	-	-	-
Follow-up Hdwy	3.5	3.3	-	-	2.236
Pot Cap-1 Maneuver	660	929	-	-	1442
Stage 1	904	-	-	-	-
Stage 2	827	-	-	-	-
Platoon blocked, %			-	-	-
Mov Cap-1 Maneuver	659	929	-	-	1442
Mov Cap-2 Maneuver	659	-	-	-	-
Stage 1	904	-	-	-	-
Stage 2	825	-	-	-	-

Approach	WB	NB	SB
HCM Control Delay, s	10.3	0	0.1
HCM LOS	B		

Minor Lane/Major Mvmt	NBT	NBRWBLn1	SBL	SBT
Capacity (veh/h)	-	-	708	1442
HCM Lane V/C Ratio	-	-	0.033	0.002
HCM Control Delay (s)	-	-	10.3	7.5
HCM Lane LOS	-	-	B	A
HCM 95th %tile Q(veh)	-	-	0.1	0

Intersection						
Int Delay, s/veh	5.5					
Movement	WBL	WBR	NBT	NBR	SBL	SBT
Lane Configurations						
Traffic Vol, veh/h	37	81	57	33	147	117
Future Vol, veh/h	37	81	57	33	147	117
Conflicting Peds, #/hr	0	0	0	0	0	0
Sign Control	Stop	Stop	Free	Free	Free	Free
RT Channelized	-	None	-	None	-	None
Storage Length	0	-	-	-	-	-
Veh in Median Storage, #	0	-	0	-	-	0
Grade, %	0	-	0	-	-	0
Peak Hour Factor	80	80	80	80	80	80
Heavy Vehicles, %	13	7	0	0	14	14
Mvmt Flow	46	101	71	41	184	146

Major/Minor	Minor1	Major1	Major2		
Conflicting Flow All	606	92	0	0	112
Stage 1	92	-	-	-	-
Stage 2	514	-	-	-	-
Critical Hdwy	6.53	6.27	-	-	4.24
Critical Hdwy Stg 1	5.53	-	-	-	-
Critical Hdwy Stg 2	5.53	-	-	-	-
Follow-up Hdwy	3.617	3.363	-	-	2.326
Pot Cap-1 Maneuver	443	952	-	-	1406
Stage 1	905	-	-	-	-
Stage 2	579	-	-	-	-
Platoon blocked, %			-	-	-
Mov Cap-1 Maneuver	380	952	-	-	1406
Mov Cap-2 Maneuver	380	-	-	-	-
Stage 1	905	-	-	-	-
Stage 2	497	-	-	-	-

Approach	WB	NB	SB
HCM Control Delay, s	12.2	0	4.4
HCM LOS	B		

Minor Lane/Major Mvmt	NBT	NBRWBLn1	SBL	SBT
Capacity (veh/h)	-	-	647	1406
HCM Lane V/C Ratio	-	-	0.228	0.131
HCM Control Delay (s)	-	-	12.2	7.9
HCM Lane LOS	-	-	B	A
HCM 95th %tile Q(veh)	-	-	0.9	0.5

HCM 6th TWSC
3: Rhododendron & tournament



01/06/2022

Intersection						
Int Delay, s/veh	0.8					
Movement	WBL	WBR	NBT	NBR	SBL	SBT
Lane Configurations	Y		T			T
Traffic Vol, veh/h	28	3	220	16	1	171
Future Vol, veh/h	28	3	220	16	1	171
Conflicting Peds, #/hr	0	0	0	0	0	0
Sign Control	Stop	Stop	Free	Free	Free	Free
RT Channelized	-	None	-	None	-	None
Storage Length	0	-	-	-	-	-
Veh in Median Storage, #	0	-	0	-	-	0
Grade, %	0	-	0	-	-	0
Peak Hour Factor	90	90	90	90	90	90
Heavy Vehicles, %	17	0	0	0	0	1
Mvmt Flow	31	3	244	18	1	190

Major/Minor	Minor1	Major1	Major2		
Conflicting Flow All	445	253	0	0	262
Stage 1	253	-	-	-	-
Stage 2	192	-	-	-	-
Critical Hdwy	6.57	6.2	-	-	4.1
Critical Hdwy Stg 1	5.57	-	-	-	-
Critical Hdwy Stg 2	5.57	-	-	-	-
Follow-up Hdwy	3.653	3.3	-	-	2.2
Pot Cap-1 Maneuver	544	791	-	-	1314
Stage 1	755	-	-	-	-
Stage 2	806	-	-	-	-
Platoon blocked, %			-	-	-
Mov Cap-1 Maneuver	543	791	-	-	1314
Mov Cap-2 Maneuver	543	-	-	-	-
Stage 1	755	-	-	-	-
Stage 2	805	-	-	-	-

Approach	WB	NB	SB
HCM Control Delay, s	11.8	0	0
HCM LOS	B		

Minor Lane/Major Mvmt	NBT	NBRWBLn1	SBL	SBT
Capacity (veh/h)	-	-	560	1314
HCM Lane V/C Ratio	-	-	0.062	0.001
HCM Control Delay (s)	-	-	11.8	7.7
HCM Lane LOS	-	-	B	A
HCM 95th %tile Q(veh)	-	-	0.2	0

Intersection						
Int Delay, s/veh	6					
Movement	WBL	WBR	NBT	NBR	SBL	SBT
Lane Configurations						
Traffic Vol, veh/h	44	164	92	56	141	117
Future Vol, veh/h	44	164	92	56	141	117
Conflicting Peds, #/hr	0	0	0	0	0	0
Sign Control	Stop	Stop	Free	Free	Free	Free
RT Channelized	-	None	-	None	-	None
Storage Length	0	-	-	-	-	-
Veh in Median Storage, #	0	-	0	-	-	0
Grade, %	0	-	0	-	-	0
Peak Hour Factor	92	92	92	92	92	92
Heavy Vehicles, %	21	3	6	17	23	0
Mvmt Flow	48	178	100	61	153	127

Major/Minor	Minor1	Major1	Major2		
Conflicting Flow All	564	131	0	0	161
Stage 1	131	-	-	-	-
Stage 2	433	-	-	-	-
Critical Hdwy	6.61	6.23	-	-	4.33
Critical Hdwy Stg 1	5.61	-	-	-	-
Critical Hdwy Stg 2	5.61	-	-	-	-
Follow-up Hdwy	3.689	3.327	-	-	2.407
Pot Cap-1 Maneuver	456	916	-	-	1300
Stage 1	850	-	-	-	-
Stage 2	615	-	-	-	-
Platoon blocked, %			-	-	-
Mov Cap-1 Maneuver	398	916	-	-	1300
Mov Cap-2 Maneuver	398	-	-	-	-
Stage 1	850	-	-	-	-
Stage 2	537	-	-	-	-

Approach	WB	NB	SB
HCM Control Delay, s	12.3	0	4.4
HCM LOS	B		

Minor Lane/Major Mvmt	NBT	NBRWBLn1	SBL	SBT
Capacity (veh/h)	-	-	718	1300
HCM Lane V/C Ratio	-	-	0.315	0.118
HCM Control Delay (s)	-	-	12.3	8.1
HCM Lane LOS	-	-	B	A
HCM 95th %tile Q(veh)	-	-	1.3	0.4

HCM 6th TWSC
3: Rhododendron & tournament

01/06/2022

Intersection						
Int Delay, s/veh	1.4					
Movement	WBL	WBR	NBT	NBR	SBL	SBT
Lane Configurations	Y		T			T
Traffic Vol, veh/h	40	6	110	16	3	179
Future Vol, veh/h	40	6	110	16	3	179
Conflicting Peds, #/hr	0	0	0	0	0	0
Sign Control	Stop	Stop	Free	Free	Free	Free
RT Channelized	-	None	-	None	-	None
Storage Length	0	-	-	-	-	-
Veh in Median Storage, #	0	-	0	-	-	0
Grade, %	0	-	0	-	-	0
Peak Hour Factor	90	90	90	90	90	90
Heavy Vehicles, %	0	0	4	0	4	0
Mvmt Flow	44	7	122	18	3	199

Major/Minor	Minor1	Major1	Major2			
Conflicting Flow All	336	131	0	0	140	0
Stage 1	131	-	-	-	-	-
Stage 2	205	-	-	-	-	-
Critical Hdwy	6.4	6.2	-	-	4.14	-
Critical Hdwy Stg 1	5.4	-	-	-	-	-
Critical Hdwy Stg 2	5.4	-	-	-	-	-
Follow-up Hdwy	3.5	3.3	-	-	2.236	-
Pot Cap-1 Maneuver	663	924	-	-	1431	-
Stage 1	900	-	-	-	-	-
Stage 2	834	-	-	-	-	-
Platoon blocked, %			-	-		-
Mov Cap-1 Maneuver	662	924	-	-	1431	-
Mov Cap-2 Maneuver	662	-	-	-	-	-
Stage 1	900	-	-	-	-	-
Stage 2	832	-	-	-	-	-

Approach	WB	NB	SB
HCM Control Delay, s	10.7	0	0.1
HCM LOS	B		

Minor Lane/Major Mvmt	NBT	NBRWBLn1	SBL	SBT
Capacity (veh/h)	-	-	687	1431
HCM Lane V/C Ratio	-	-	0.074	0.002
HCM Control Delay (s)	-	-	10.7	7.5
HCM Lane LOS	-	-	B	A
HCM 95th %tile Q(veh)	-	-	0.2	0

Intersection						
Int Delay, s/veh	5.6					
Movement	WBL	WBR	NBT	NBR	SBL	SBT
Lane Configurations						
Traffic Vol, veh/h	37	85	61	33	159	129
Future Vol, veh/h	37	85	61	33	159	129
Conflicting Peds, #/hr	0	0	0	0	0	0
Sign Control	Stop	Stop	Free	Free	Free	Free
RT Channelized	-	None	-	None	-	None
Storage Length	0	-	-	-	-	-
Veh in Median Storage, #	0	-	0	-	-	0
Grade, %	0	-	0	-	-	0
Peak Hour Factor	80	80	80	80	80	80
Heavy Vehicles, %	13	7	0	0	14	14
Mvmt Flow	46	106	76	41	199	161

Major/Minor	Minor1	Major1	Major2			
Conflicting Flow All	656	97	0	0	117	0
Stage 1	97	-	-	-	-	-
Stage 2	559	-	-	-	-	-
Critical Hdwy	6.53	6.27	-	-	4.24	-
Critical Hdwy Stg 1	5.53	-	-	-	-	-
Critical Hdwy Stg 2	5.53	-	-	-	-	-
Follow-up Hdwy	3.617	3.363	-	-	2.326	-
Pot Cap-1 Maneuver	413	946	-	-	1400	-
Stage 1	900	-	-	-	-	-
Stage 2	551	-	-	-	-	-
Platoon blocked, %			-	-		-
Mov Cap-1 Maneuver	349	946	-	-	1400	-
Mov Cap-2 Maneuver	349	-	-	-	-	-
Stage 1	900	-	-	-	-	-
Stage 2	465	-	-	-	-	-

Approach	WB	NB	SB
HCM Control Delay, s	12.6	0	4.4
HCM LOS	B		

Minor Lane/Major Mvmt	NBT	NBRWBLn1	SBL	SBT
Capacity (veh/h)	-	-	623	1400
HCM Lane V/C Ratio	-	-	0.245	0.142
HCM Control Delay (s)	-	-	12.6	8
HCM Lane LOS	-	-	B	A
HCM 95th %tile Q(veh)	-	-	1	0.5

HCM 6th TWSC
 3: Rhododendron & tournament

01/06/2022

Intersection						
Int Delay, s/veh	1.2					
Movement	WBL	WBR	NBT	NBR	SBL	SBT
Lane Configurations	Y		T			T
Traffic Vol, veh/h	43	4	220	42	3	171
Future Vol, veh/h	43	4	220	42	3	171
Conflicting Peds, #/hr	0	0	0	0	0	0
Sign Control	Stop	Stop	Free	Free	Free	Free
RT Channelized	-	None	-	None	-	None
Storage Length	0	-	-	-	-	-
Veh in Median Storage, #	0	-	0	-	-	0
Grade, %	0	-	0	-	-	0
Peak Hour Factor	90	90	90	90	90	90
Heavy Vehicles, %	17	0	0	0	0	1
Mvmt Flow	48	4	244	47	3	190

Major/Minor	Minor1	Major1	Major2		
Conflicting Flow All	464	268	0	0	291
Stage 1	268	-	-	-	-
Stage 2	196	-	-	-	-
Critical Hdwy	6.57	6.2	-	-	4.1
Critical Hdwy Stg 1	5.57	-	-	-	-
Critical Hdwy Stg 2	5.57	-	-	-	-
Follow-up Hdwy	3.653	3.3	-	-	2.2
Pot Cap-1 Maneuver	530	776	-	-	1282
Stage 1	744	-	-	-	-
Stage 2	802	-	-	-	-
Platoon blocked, %			-	-	-
Mov Cap-1 Maneuver	528	776	-	-	1282
Mov Cap-2 Maneuver	528	-	-	-	-
Stage 1	744	-	-	-	-
Stage 2	800	-	-	-	-

Approach	WB	NB	SB
HCM Control Delay, s	12.3	0	0.1
HCM LOS	B		

Minor Lane/Major Mvmt	NBT	NBRWBLn1	SBL	SBT
Capacity (veh/h)	-	-	543	1282
HCM Lane V/C Ratio	-	-	0.096	0.003
HCM Control Delay (s)	-	-	12.3	7.8
HCM Lane LOS	-	-	B	A
HCM 95th %tile Q(veh)	-	-	0.3	0

Intersection						
Int Delay, s/veh	6.2					
Movement	WBL	WBR	NBT	NBR	SBL	SBT
Lane Configurations						
Traffic Vol, veh/h	44	177	105	56	148	125
Future Vol, veh/h	44	177	105	56	148	125
Conflicting Peds, #/hr	0	0	0	0	0	0
Sign Control	Stop	Stop	Free	Free	Free	Free
RT Channelized	-	None	-	None	-	None
Storage Length	0	-	-	-	-	-
Veh in Median Storage, #	0	-	0	-	-	0
Grade, %	0	-	0	-	-	0
Peak Hour Factor	92	92	92	92	92	92
Heavy Vehicles, %	21	3	6	17	23	0
Mvmt Flow	48	192	114	61	161	136

Major/Minor	Minor1	Major1	Major2		
Conflicting Flow All	603	145	0	0	175
Stage 1	145	-	-	-	-
Stage 2	458	-	-	-	-
Critical Hdwy	6.61	6.23	-	-	4.33
Critical Hdwy Stg 1	5.61	-	-	-	-
Critical Hdwy Stg 2	5.61	-	-	-	-
Follow-up Hdwy	3.689	3.327	-	-	2.407
Pot Cap-1 Maneuver	432	900	-	-	1284
Stage 1	838	-	-	-	-
Stage 2	599	-	-	-	-
Platoon blocked, %			-	-	-
Mov Cap-1 Maneuver	373	900	-	-	1284
Mov Cap-2 Maneuver	373	-	-	-	-
Stage 1	838	-	-	-	-
Stage 2	518	-	-	-	-

Approach	WB	NB	SB
HCM Control Delay, s	12.8	0	4.4
HCM LOS	B		

Minor Lane/Major Mvmt	NBT	NBRWBLn1	SBL	SBT
Capacity (veh/h)	-	-	702	1284
HCM Lane V/C Ratio	-	-	0.342	0.125
HCM Control Delay (s)	-	-	12.8	8.2
HCM Lane LOS	-	-	B	A
HCM 95th %tile Q(veh)	-	-	1.5	0.4

Fairway Estates

Intersection: 3: Rhododendron & tournament, Interval #0

Movement	WB
Directions Served	LR
Maximum Queue (ft)	30
Average Queue (ft)	15
95th Queue (ft)	40
Link Distance (ft)	694
Upstream Blk Time (%)	
Queuing Penalty (veh)	
Storage Bay Dist (ft)	
Storage Blk Time (%)	
Queuing Penalty (veh)	

Intersection: 3: Rhododendron & tournament, Interval #1

Movement	WB
Directions Served	LR
Maximum Queue (ft)	30
Average Queue (ft)	15
95th Queue (ft)	40
Link Distance (ft)	694
Upstream Blk Time (%)	
Queuing Penalty (veh)	
Storage Bay Dist (ft)	
Storage Blk Time (%)	
Queuing Penalty (veh)	

Intersection: 3: Rhododendron & tournament, Interval #2

Movement	WB	SB
Directions Served	LR	LT
Maximum Queue (ft)	39	6
Average Queue (ft)	12	0
95th Queue (ft)	37	5
Link Distance (ft)	694	612
Upstream Blk Time (%)		
Queuing Penalty (veh)		
Storage Bay Dist (ft)		
Storage Blk Time (%)		
Queuing Penalty (veh)		

Intersection: 3: Rhododendron & tournament, All Intervals

Movement	WB	SB
Directions Served	LR	LT
Maximum Queue (ft)	39	6
Average Queue (ft)	13	0
95th Queue (ft)	38	4
Link Distance (ft)	694	612
Upstream Blk Time (%)		
Queuing Penalty (veh)		
Storage Bay Dist (ft)		
Storage Blk Time (%)		
Queuing Penalty (veh)		

Intersection: 5: Rhododendron & 35th st, Interval #0

Movement	WB	SB
Directions Served	LR	LT
Maximum Queue (ft)	74	65
Average Queue (ft)	49	32
95th Queue (ft)	77	76
Link Distance (ft)	880	1300
Upstream Blk Time (%)		
Queuing Penalty (veh)		
Storage Bay Dist (ft)		
Storage Blk Time (%)		
Queuing Penalty (veh)		

Intersection: 5: Rhododendron & 35th st, Interval #1

Movement	WB	NB	SB
Directions Served	LR	TR	LT
Maximum Queue (ft)	78	4	62
Average Queue (ft)	46	1	26
95th Queue (ft)	86	6	64
Link Distance (ft)	880	444	1300
Upstream Blk Time (%)			
Queuing Penalty (veh)			
Storage Bay Dist (ft)			
Storage Blk Time (%)			
Queuing Penalty (veh)			

Intersection: 5: Rhododendron & 35th st, Interval #2

Movement	WB	SB
Directions Served	LR	LT
Maximum Queue (ft)	87	64
Average Queue (ft)	39	11
95th Queue (ft)	67	43
Link Distance (ft)	880	1300
Upstream Blk Time (%)		
Queuing Penalty (veh)		
Storage Bay Dist (ft)		
Storage Blk Time (%)		
Queuing Penalty (veh)		

Intersection: 5: Rhododendron & 35th st, All Intervals

Movement	WB	NB	SB
Directions Served	LR	TR	LT
Maximum Queue (ft)	93	4	84
Average Queue (ft)	42	0	17
95th Queue (ft)	73	3	55
Link Distance (ft)	880	444	1300
Upstream Blk Time (%)			
Queuing Penalty (veh)			
Storage Bay Dist (ft)			
Storage Blk Time (%)			
Queuing Penalty (veh)			

Network Summary

Network wide Queuing Penalty, Interval #0: 0
Network wide Queuing Penalty, Interval #1: 0
Network wide Queuing Penalty, Interval #2: 0
Network wide Queuing Penalty, All Intervals: 0

Intersection: 3: Rhododendron & tournament, Interval #0

Movement	WB	SB
Directions Served	LR	LT
Maximum Queue (ft)	46	6
Average Queue (ft)	24	1
95th Queue (ft)	54	11
Link Distance (ft)	694	612
Upstream Blk Time (%)		
Queuing Penalty (veh)		
Storage Bay Dist (ft)		
Storage Blk Time (%)		
Queuing Penalty (veh)		

Intersection: 3: Rhododendron & tournament, Interval #1

Movement	WB
Directions Served	LR
Maximum Queue (ft)	54
Average Queue (ft)	20
95th Queue (ft)	56
Link Distance (ft)	694
Upstream Blk Time (%)	
Queuing Penalty (veh)	
Storage Bay Dist (ft)	
Storage Blk Time (%)	
Queuing Penalty (veh)	

Intersection: 3: Rhododendron & tournament, Interval #2

Movement	WB
Directions Served	LR
Maximum Queue (ft)	61
Average Queue (ft)	19
95th Queue (ft)	51
Link Distance (ft)	694
Upstream Blk Time (%)	
Queuing Penalty (veh)	
Storage Bay Dist (ft)	
Storage Blk Time (%)	
Queuing Penalty (veh)	

Intersection: 3: Rhododendron & tournament, All Intervals

Movement	WB	SB
Directions Served	LR	LT
Maximum Queue (ft)	63	6
Average Queue (ft)	20	0
95th Queue (ft)	52	4
Link Distance (ft)	694	612
Upstream Blk Time (%)		
Queuing Penalty (veh)		
Storage Bay Dist (ft)		
Storage Blk Time (%)		
Queuing Penalty (veh)		

Intersection: 5: Rhododendron & 35th st, Interval #0

Movement	WB	NB	SB
Directions Served	LR	TR	LT
Maximum Queue (ft)	85	8	75
Average Queue (ft)	58	2	28
95th Queue (ft)	103	15	89
Link Distance (ft)	880	444	1300
Upstream Blk Time (%)			
Queuing Penalty (veh)			
Storage Bay Dist (ft)			
Storage Blk Time (%)			
Queuing Penalty (veh)			

Intersection: 5: Rhododendron & 35th st, Interval #1

Movement	WB	SB
Directions Served	LR	LT
Maximum Queue (ft)	86	66
Average Queue (ft)	52	24
95th Queue (ft)	86	69
Link Distance (ft)	880	1300
Upstream Blk Time (%)		
Queuing Penalty (veh)		
Storage Bay Dist (ft)		
Storage Blk Time (%)		
Queuing Penalty (veh)		

Intersection: 5: Rhododendron & 35th st, Interval #2

Movement	WB	NB	SB
Directions Served	LR	TR	LT
Maximum Queue (ft)	100	4	91
Average Queue (ft)	52	0	23
95th Queue (ft)	84	4	72
Link Distance (ft)	880	444	1300
Upstream Blk Time (%)			
Queuing Penalty (veh)			
Storage Bay Dist (ft)			
Storage Blk Time (%)			
Queuing Penalty (veh)			

Intersection: 5: Rhododendron & 35th st, All Intervals

Movement	WB	NB	SB
Directions Served	LR	TR	LT
Maximum Queue (ft)	111	12	112
Average Queue (ft)	53	0	24
95th Queue (ft)	88	6	74
Link Distance (ft)	880	444	1300
Upstream Blk Time (%)			
Queuing Penalty (veh)			
Storage Bay Dist (ft)			
Storage Blk Time (%)			
Queuing Penalty (veh)			

Network Summary

Network wide Queuing Penalty, Interval #0: 0
Network wide Queuing Penalty, Interval #1: 0
Network wide Queuing Penalty, Interval #2: 0
Network wide Queuing Penalty, All Intervals: 0

Intersection: 3: Rhododendron & tournament, Interval #0

Movement	WB
Directions Served	LR
Maximum Queue (ft)	35
Average Queue (ft)	14
95th Queue (ft)	41
Link Distance (ft)	694
Upstream Blk Time (%)	
Queuing Penalty (veh)	
Storage Bay Dist (ft)	
Storage Blk Time (%)	
Queuing Penalty (veh)	

Intersection: 3: Rhododendron & tournament, Interval #1

Movement	WB
Directions Served	LR
Maximum Queue (ft)	30
Average Queue (ft)	11
95th Queue (ft)	34
Link Distance (ft)	694
Upstream Blk Time (%)	
Queuing Penalty (veh)	
Storage Bay Dist (ft)	
Storage Blk Time (%)	
Queuing Penalty (veh)	

Intersection: 3: Rhododendron & tournament, Interval #2

Movement	WB	SB
Directions Served	LR	LT
Maximum Queue (ft)	30	6
Average Queue (ft)	15	0
95th Queue (ft)	39	5
Link Distance (ft)	694	612
Upstream Blk Time (%)		
Queuing Penalty (veh)		
Storage Bay Dist (ft)		
Storage Blk Time (%)		
Queuing Penalty (veh)		

Intersection: 3: Rhododendron & tournament, All Intervals

Movement	WB	SB
Directions Served	LR	LT
Maximum Queue (ft)	35	6
Average Queue (ft)	14	0
95th Queue (ft)	39	4
Link Distance (ft)	694	612
Upstream Blk Time (%)		
Queuing Penalty (veh)		
Storage Bay Dist (ft)		
Storage Blk Time (%)		
Queuing Penalty (veh)		

Intersection: 5: Rhododendron & 35th st, Interval #0

Movement	WB	SB
Directions Served	LR	LT
Maximum Queue (ft)	62	48
Average Queue (ft)	44	24
95th Queue (ft)	73	63
Link Distance (ft)	880	1300
Upstream Blk Time (%)		
Queuing Penalty (veh)		
Storage Bay Dist (ft)		
Storage Blk Time (%)		
Queuing Penalty (veh)		

Intersection: 5: Rhododendron & 35th st, Interval #1

Movement	WB	NB	SB
Directions Served	LR	TR	LT
Maximum Queue (ft)	75	4	68
Average Queue (ft)	50	1	21
95th Queue (ft)	82	7	67
Link Distance (ft)	880	444	1300
Upstream Blk Time (%)			
Queuing Penalty (veh)			
Storage Bay Dist (ft)			
Storage Blk Time (%)			
Queuing Penalty (veh)			

Intersection: 5: Rhododendron & 35th st, Interval #2

Movement	WB	SB
Directions Served	LR	LT
Maximum Queue (ft)	79	69
Average Queue (ft)	39	14
95th Queue (ft)	66	50
Link Distance (ft)	880	1300
Upstream Blk Time (%)		
Queuing Penalty (veh)		
Storage Bay Dist (ft)		
Storage Blk Time (%)		
Queuing Penalty (veh)		

Intersection: 5: Rhododendron & 35th st, All Intervals

Movement	WB	NB	SB
Directions Served	LR	TR	LT
Maximum Queue (ft)	80	4	78
Average Queue (ft)	42	0	17
95th Queue (ft)	71	3	56
Link Distance (ft)	880	444	1300
Upstream Blk Time (%)			
Queuing Penalty (veh)			
Storage Bay Dist (ft)			
Storage Blk Time (%)			
Queuing Penalty (veh)			

Network Summary

Network wide Queuing Penalty, Interval #0: 0
Network wide Queuing Penalty, Interval #1: 0
Network wide Queuing Penalty, Interval #2: 0
Network wide Queuing Penalty, All Intervals: 0

Intersection: 3: Rhododendron & tournament, Interval #0

Movement	WB
Directions Served	LR
Maximum Queue (ft)	47
Average Queue (ft)	28
95th Queue (ft)	56
Link Distance (ft)	694
Upstream Blk Time (%)	
Queuing Penalty (veh)	
Storage Bay Dist (ft)	
Storage Blk Time (%)	
Queuing Penalty (veh)	

Intersection: 3: Rhododendron & tournament, Interval #1

Movement	WB
Directions Served	LR
Maximum Queue (ft)	45
Average Queue (ft)	20
95th Queue (ft)	51
Link Distance (ft)	694
Upstream Blk Time (%)	
Queuing Penalty (veh)	
Storage Bay Dist (ft)	
Storage Blk Time (%)	
Queuing Penalty (veh)	

Intersection: 3: Rhododendron & tournament, Interval #2

Movement	WB	SB
Directions Served	LR	LT
Maximum Queue (ft)	65	6
Average Queue (ft)	23	0
95th Queue (ft)	53	5
Link Distance (ft)	694	612
Upstream Blk Time (%)		
Queuing Penalty (veh)		
Storage Bay Dist (ft)		
Storage Blk Time (%)		
Queuing Penalty (veh)		

Intersection: 3: Rhododendron & tournament, All Intervals

Movement	WB	SB
Directions Served	LR	LT
Maximum Queue (ft)	65	6
Average Queue (ft)	23	0
95th Queue (ft)	53	4
Link Distance (ft)	694	612
Upstream Blk Time (%)		
Queuing Penalty (veh)		
Storage Bay Dist (ft)		
Storage Blk Time (%)		
Queuing Penalty (veh)		

Intersection: 5: Rhododendron & 35th st, Interval #0

Movement	WB	SB
Directions Served	LR	LT
Maximum Queue (ft)	109	53
Average Queue (ft)	61	19
95th Queue (ft)	114	55
Link Distance (ft)	880	1300
Upstream Blk Time (%)		
Queuing Penalty (veh)		
Storage Bay Dist (ft)		
Storage Blk Time (%)		
Queuing Penalty (veh)		

Intersection: 5: Rhododendron & 35th st, Interval #1

Movement	WB	NB	SB
Directions Served	LR	TR	LT
Maximum Queue (ft)	79	4	72
Average Queue (ft)	52	1	29
95th Queue (ft)	79	7	72
Link Distance (ft)	880	444	1300
Upstream Blk Time (%)			
Queuing Penalty (veh)			
Storage Bay Dist (ft)			
Storage Blk Time (%)			
Queuing Penalty (veh)			

Intersection: 5: Rhododendron & 35th st, Interval #2

Movement	WB	NB	SB
Directions Served	LR	TR	LT
Maximum Queue (ft)	111	23	90
Average Queue (ft)	56	1	27
95th Queue (ft)	92	12	71
Link Distance (ft)	880	444	1300
Upstream Blk Time (%)			
Queuing Penalty (veh)			
Storage Bay Dist (ft)			
Storage Blk Time (%)			
Queuing Penalty (veh)			

Intersection: 5: Rhododendron & 35th st, All Intervals

Movement	WB	NB	SB
Directions Served	LR	TR	LT
Maximum Queue (ft)	126	27	95
Average Queue (ft)	56	1	26
95th Queue (ft)	94	10	69
Link Distance (ft)	880	444	1300
Upstream Blk Time (%)			
Queuing Penalty (veh)			
Storage Bay Dist (ft)			
Storage Blk Time (%)			
Queuing Penalty (veh)			

Network Summary

Network wide Queuing Penalty, Interval #0: 0
Network wide Queuing Penalty, Interval #1: 0
Network wide Queuing Penalty, Interval #2: 0
Network wide Queuing Penalty, All Intervals: 0

Intersection: 3: Rhododendron & tournament, Interval #0

Movement	WB
Directions Served	LR
Maximum Queue (ft)	34
Average Queue (ft)	25
95th Queue (ft)	45
Link Distance (ft)	694
Upstream Blk Time (%)	
Queuing Penalty (veh)	
Storage Bay Dist (ft)	
Storage Blk Time (%)	
Queuing Penalty (veh)	

Intersection: 3: Rhododendron & tournament, Interval #1

Movement	WB
Directions Served	LR
Maximum Queue (ft)	39
Average Queue (ft)	25
95th Queue (ft)	47
Link Distance (ft)	694
Upstream Blk Time (%)	
Queuing Penalty (veh)	
Storage Bay Dist (ft)	
Storage Blk Time (%)	
Queuing Penalty (veh)	

Intersection: 3: Rhododendron & tournament, Interval #2

Movement	WB
Directions Served	LR
Maximum Queue (ft)	44
Average Queue (ft)	22
95th Queue (ft)	46
Link Distance (ft)	694
Upstream Blk Time (%)	
Queuing Penalty (veh)	
Storage Bay Dist (ft)	
Storage Blk Time (%)	
Queuing Penalty (veh)	

Intersection: 3: Rhododendron & tournament, All Intervals

Movement	WB
Directions Served	LR
Maximum Queue (ft)	52
Average Queue (ft)	23
95th Queue (ft)	46
Link Distance (ft)	694
Upstream Blk Time (%)	
Queuing Penalty (veh)	
Storage Bay Dist (ft)	
Storage Blk Time (%)	
Queuing Penalty (veh)	

Intersection: 5: Rhododendron & 35th st, Interval #0

Movement	WB	SB
Directions Served	LR	LT
Maximum Queue (ft)	62	68
Average Queue (ft)	44	23
95th Queue (ft)	72	74
Link Distance (ft)	880	1300
Upstream Blk Time (%)		
Queuing Penalty (veh)		
Storage Bay Dist (ft)		
Storage Blk Time (%)		
Queuing Penalty (veh)		

Intersection: 5: Rhododendron & 35th st, Interval #1

Movement	WB	SB
Directions Served	LR	LT
Maximum Queue (ft)	83	108
Average Queue (ft)	49	33
95th Queue (ft)	83	99
Link Distance (ft)	880	1300
Upstream Blk Time (%)		
Queuing Penalty (veh)		
Storage Bay Dist (ft)		
Storage Blk Time (%)		
Queuing Penalty (veh)		

Intersection: 5: Rhododendron & 35th st, Interval #2

Movement	WB	NB	SB
Directions Served	LR	TR	LT
Maximum Queue (ft)	85	4	66
Average Queue (ft)	38	0	19
95th Queue (ft)	68	3	57
Link Distance (ft)	880	444	1300
Upstream Blk Time (%)			
Queuing Penalty (veh)			
Storage Bay Dist (ft)			
Storage Blk Time (%)			
Queuing Penalty (veh)			

Intersection: 5: Rhododendron & 35th st, All Intervals

Movement	WB	NB	SB
Directions Served	LR	TR	LT
Maximum Queue (ft)	94	4	111
Average Queue (ft)	41	0	22
95th Queue (ft)	73	3	70
Link Distance (ft)	880	444	1300
Upstream Blk Time (%)			
Queuing Penalty (veh)			
Storage Bay Dist (ft)			
Storage Blk Time (%)			
Queuing Penalty (veh)			

Network Summary

Network wide Queuing Penalty, Interval #0: 0
Network wide Queuing Penalty, Interval #1: 0
Network wide Queuing Penalty, Interval #2: 0
Network wide Queuing Penalty, All Intervals: 0

Intersection: 3: Rhododendron & tournament, Interval #0

Movement	WB	SB
Directions Served	LR	LT
Maximum Queue (ft)	63	6
Average Queue (ft)	32	1
95th Queue (ft)	71	10
Link Distance (ft)	694	612
Upstream Blk Time (%)		
Queuing Penalty (veh)		
Storage Bay Dist (ft)		
Storage Blk Time (%)		
Queuing Penalty (veh)		

Intersection: 3: Rhododendron & tournament, Interval #1

Movement	WB
Directions Served	LR
Maximum Queue (ft)	63
Average Queue (ft)	34
95th Queue (ft)	67
Link Distance (ft)	694
Upstream Blk Time (%)	
Queuing Penalty (veh)	
Storage Bay Dist (ft)	
Storage Blk Time (%)	
Queuing Penalty (veh)	

Intersection: 3: Rhododendron & tournament, Interval #2

Movement	WB	SB
Directions Served	LR	LT
Maximum Queue (ft)	71	6
Average Queue (ft)	27	0
95th Queue (ft)	61	5
Link Distance (ft)	694	612
Upstream Blk Time (%)		
Queuing Penalty (veh)		
Storage Bay Dist (ft)		
Storage Blk Time (%)		
Queuing Penalty (veh)		

Intersection: 3: Rhododendron & tournament, All Intervals

Movement	WB	SB
Directions Served	LR	LT
Maximum Queue (ft)	77	12
Average Queue (ft)	29	0
95th Queue (ft)	64	6
Link Distance (ft)	694	612
Upstream Blk Time (%)		
Queuing Penalty (veh)		
Storage Bay Dist (ft)		
Storage Blk Time (%)		
Queuing Penalty (veh)		

Intersection: 5: Rhododendron & 35th st, Interval #0

Movement	WB	NB	SB
Directions Served	LR	TR	LT
Maximum Queue (ft)	89	11	56
Average Queue (ft)	59	2	21
95th Queue (ft)	106	20	66
Link Distance (ft)	880	444	1300
Upstream Blk Time (%)			
Queuing Penalty (veh)			
Storage Bay Dist (ft)			
Storage Blk Time (%)			
Queuing Penalty (veh)			

Intersection: 5: Rhododendron & 35th st, Interval #1

Movement	WB	NB	SB
Directions Served	LR	TR	LT
Maximum Queue (ft)	88	4	84
Average Queue (ft)	54	1	33
95th Queue (ft)	89	7	84
Link Distance (ft)	880	444	1300
Upstream Blk Time (%)			
Queuing Penalty (veh)			
Storage Bay Dist (ft)			
Storage Blk Time (%)			
Queuing Penalty (veh)			

Intersection: 5: Rhododendron & 35th st, Interval #2

Movement	WB	NB	SB
Directions Served	LR	TR	LT
Maximum Queue (ft)	111	19	90
Average Queue (ft)	53	1	27
95th Queue (ft)	86	12	73
Link Distance (ft)	880	444	1300
Upstream Blk Time (%)			
Queuing Penalty (veh)			
Storage Bay Dist (ft)			
Storage Blk Time (%)			
Queuing Penalty (veh)			

Intersection: 5: Rhododendron & 35th st, All Intervals

Movement	WB	NB	SB
Directions Served	LR	TR	LT
Maximum Queue (ft)	115	35	98
Average Queue (ft)	54	1	28
95th Queue (ft)	90	12	75
Link Distance (ft)	880	444	1300
Upstream Blk Time (%)			
Queuing Penalty (veh)			
Storage Bay Dist (ft)			
Storage Blk Time (%)			
Queuing Penalty (veh)			

Network Summary

Network wide Queuing Penalty, Interval #0: 0
Network wide Queuing Penalty, Interval #1: 0
Network wide Queuing Penalty, Interval #2: 0
Network wide Queuing Penalty, All Intervals: 0

Intersection: 3: Rhododendron & tournament, Interval #0

Movement	WB	SB
Directions Served	LR	LT
Maximum Queue (ft)	30	10
Average Queue (ft)	14	2
95th Queue (ft)	39	19
Link Distance (ft)	694	612
Upstream Blk Time (%)		
Queuing Penalty (veh)		
Storage Bay Dist (ft)		
Storage Blk Time (%)		
Queuing Penalty (veh)		

Intersection: 3: Rhododendron & tournament, Interval #1

Movement	WB	SB
Directions Served	LR	LT
Maximum Queue (ft)	30	6
Average Queue (ft)	14	0
95th Queue (ft)	38	0
Link Distance (ft)	694	612
Upstream Blk Time (%)		
Queuing Penalty (veh)		
Storage Bay Dist (ft)		
Storage Blk Time (%)		
Queuing Penalty (veh)		

Intersection: 3: Rhododendron & tournament, Interval #2

Movement	WB	SB
Directions Served	LR	LT
Maximum Queue (ft)	35	6
Average Queue (ft)	15	0
95th Queue (ft)	40	5
Link Distance (ft)	694	612
Upstream Blk Time (%)		
Queuing Penalty (veh)		
Storage Bay Dist (ft)		
Storage Blk Time (%)		
Queuing Penalty (veh)		

Intersection: 3: Rhododendron & tournament, All Intervals

Movement	WB	SB
Directions Served	LR	LT
Maximum Queue (ft)	35	23
Average Queue (ft)	15	0
95th Queue (ft)	40	8
Link Distance (ft)	694	612
Upstream Blk Time (%)		
Queuing Penalty (veh)		
Storage Bay Dist (ft)		
Storage Blk Time (%)		
Queuing Penalty (veh)		

Intersection: 5: Rhododendron & 35th st, Interval #0

Movement	WB	SB
Directions Served	LR	LT
Maximum Queue (ft)	76	82
Average Queue (ft)	49	34
95th Queue (ft)	83	90
Link Distance (ft)	880	1300
Upstream Blk Time (%)		
Queuing Penalty (veh)		
Storage Bay Dist (ft)		
Storage Blk Time (%)		
Queuing Penalty (veh)		

Intersection: 5: Rhododendron & 35th st, Interval #1

Movement	WB	NB	SB
Directions Served	LR	TR	LT
Maximum Queue (ft)	78	8	89
Average Queue (ft)	52	1	31
95th Queue (ft)	84	9	85
Link Distance (ft)	880	444	1300
Upstream Blk Time (%)			
Queuing Penalty (veh)			
Storage Bay Dist (ft)			
Storage Blk Time (%)			
Queuing Penalty (veh)			

Intersection: 5: Rhododendron & 35th st, Interval #2

Movement	WB	SB
Directions Served	LR	LT
Maximum Queue (ft)	82	77
Average Queue (ft)	42	13
95th Queue (ft)	73	47
Link Distance (ft)	880	1300
Upstream Blk Time (%)		
Queuing Penalty (veh)		
Storage Bay Dist (ft)		
Storage Blk Time (%)		
Queuing Penalty (veh)		

Intersection: 5: Rhododendron & 35th st, All Intervals

Movement	WB	NB	SB
Directions Served	LR	TR	LT
Maximum Queue (ft)	91	8	101
Average Queue (ft)	45	0	20
95th Queue (ft)	78	4	65
Link Distance (ft)	880	444	1300
Upstream Blk Time (%)			
Queuing Penalty (veh)			
Storage Bay Dist (ft)			
Storage Blk Time (%)			
Queuing Penalty (veh)			

Network Summary

Network wide Queuing Penalty, Interval #0: 0
Network wide Queuing Penalty, Interval #1: 0
Network wide Queuing Penalty, Interval #2: 0
Network wide Queuing Penalty, All Intervals: 0

Intersection: 3: Rhododendron & tournament, Interval #0

Movement	WB	SB
Directions Served	LR	LT
Maximum Queue (ft)	46	6
Average Queue (ft)	28	1
95th Queue (ft)	62	10
Link Distance (ft)	694	612
Upstream Blk Time (%)		
Queuing Penalty (veh)		
Storage Bay Dist (ft)		
Storage Blk Time (%)		
Queuing Penalty (veh)		

Intersection: 3: Rhododendron & tournament, Interval #1

Movement	WB
Directions Served	LR
Maximum Queue (ft)	62
Average Queue (ft)	28
95th Queue (ft)	66
Link Distance (ft)	694
Upstream Blk Time (%)	
Queuing Penalty (veh)	
Storage Bay Dist (ft)	
Storage Blk Time (%)	
Queuing Penalty (veh)	

Intersection: 3: Rhododendron & tournament, Interval #2

Movement	WB
Directions Served	LR
Maximum Queue (ft)	73
Average Queue (ft)	25
95th Queue (ft)	60
Link Distance (ft)	694
Upstream Blk Time (%)	
Queuing Penalty (veh)	
Storage Bay Dist (ft)	
Storage Blk Time (%)	
Queuing Penalty (veh)	

Intersection: 3: Rhododendron & tournament, All Intervals

Movement	WB	SB
Directions Served	LR	LT
Maximum Queue (ft)	79	6
Average Queue (ft)	26	0
95th Queue (ft)	62	4
Link Distance (ft)	694	612
Upstream Blk Time (%)		
Queuing Penalty (veh)		
Storage Bay Dist (ft)		
Storage Blk Time (%)		
Queuing Penalty (veh)		

Intersection: 5: Rhododendron & 35th st, Interval #0

Movement	WB	SB
Directions Served	LR	LT
Maximum Queue (ft)	84	63
Average Queue (ft)	61	36
95th Queue (ft)	96	77
Link Distance (ft)	880	1300
Upstream Blk Time (%)		
Queuing Penalty (veh)		
Storage Bay Dist (ft)		
Storage Blk Time (%)		
Queuing Penalty (veh)		

Intersection: 5: Rhododendron & 35th st, Interval #1

Movement	WB	NB	SB
Directions Served	LR	TR	LT
Maximum Queue (ft)	110	4	80
Average Queue (ft)	64	1	37
95th Queue (ft)	114	7	84
Link Distance (ft)	880	444	1300
Upstream Blk Time (%)			
Queuing Penalty (veh)			
Storage Bay Dist (ft)			
Storage Blk Time (%)			
Queuing Penalty (veh)			

Intersection: 5: Rhododendron & 35th st, Interval #2

Movement	WB	NB	SB
Directions Served	LR	TR	LT
Maximum Queue (ft)	118	4	94
Average Queue (ft)	52	0	24
95th Queue (ft)	91	3	72
Link Distance (ft)	880	444	1300
Upstream Blk Time (%)			
Queuing Penalty (veh)			
Storage Bay Dist (ft)			
Storage Blk Time (%)			
Queuing Penalty (veh)			

Intersection: 5: Rhododendron & 35th st, All Intervals

Movement	WB	NB	SB
Directions Served	LR	TR	LT
Maximum Queue (ft)	129	8	99
Average Queue (ft)	56	0	28
95th Queue (ft)	97	4	76
Link Distance (ft)	880	444	1300
Upstream Blk Time (%)			
Queuing Penalty (veh)			
Storage Bay Dist (ft)			
Storage Blk Time (%)			
Queuing Penalty (veh)			

Network Summary

Network wide Queuing Penalty, Interval #0: 0
Network wide Queuing Penalty, Interval #1: 0
Network wide Queuing Penalty, Interval #2: 0
Network wide Queuing Penalty, All Intervals: 0

Intersection: 3: Rhododendron & tournament, Interval #0

Movement	WB
Directions Served	LR
Maximum Queue (ft)	44
Average Queue (ft)	25
95th Queue (ft)	54
Link Distance (ft)	694
Upstream Blk Time (%)	
Queuing Penalty (veh)	
Storage Bay Dist (ft)	
Storage Blk Time (%)	
Queuing Penalty (veh)	

Intersection: 3: Rhododendron & tournament, Interval #1

Movement	WB	SB
Directions Served	LR	LT
Maximum Queue (ft)	39	6
Average Queue (ft)	26	1
95th Queue (ft)	45	9
Link Distance (ft)	694	612
Upstream Blk Time (%)		
Queuing Penalty (veh)		
Storage Bay Dist (ft)		
Storage Blk Time (%)		
Queuing Penalty (veh)		

Intersection: 3: Rhododendron & tournament, Interval #2

Movement	WB	SB
Directions Served	LR	LT
Maximum Queue (ft)	47	6
Average Queue (ft)	23	0
95th Queue (ft)	49	5
Link Distance (ft)	694	612
Upstream Blk Time (%)		
Queuing Penalty (veh)		
Storage Bay Dist (ft)		
Storage Blk Time (%)		
Queuing Penalty (veh)		

Intersection: 3: Rhododendron & tournament, All Intervals

Movement	WB	SB
Directions Served	LR	LT
Maximum Queue (ft)	47	12
Average Queue (ft)	24	0
95th Queue (ft)	49	5
Link Distance (ft)	694	612
Upstream Blk Time (%)		
Queuing Penalty (veh)		
Storage Bay Dist (ft)		
Storage Blk Time (%)		
Queuing Penalty (veh)		

Intersection: 5: Rhododendron & 35th st, Interval #0

Movement	WB	NB	SB
Directions Served	LR	TR	LT
Maximum Queue (ft)	67	4	56
Average Queue (ft)	46	1	23
95th Queue (ft)	73	8	65
Link Distance (ft)	880	444	1300
Upstream Blk Time (%)			
Queuing Penalty (veh)			
Storage Bay Dist (ft)			
Storage Blk Time (%)			
Queuing Penalty (veh)			

Intersection: 5: Rhododendron & 35th st, Interval #1

Movement	WB	SB
Directions Served	LR	LT
Maximum Queue (ft)	77	59
Average Queue (ft)	51	27
95th Queue (ft)	82	68
Link Distance (ft)	880	1300
Upstream Blk Time (%)		
Queuing Penalty (veh)		
Storage Bay Dist (ft)		
Storage Blk Time (%)		
Queuing Penalty (veh)		

Intersection: 5: Rhododendron & 35th st, Interval #2

Movement	WB	SB
Directions Served	LR	LT
Maximum Queue (ft)	86	72
Average Queue (ft)	43	13
95th Queue (ft)	75	47
Link Distance (ft)	880	1300
Upstream Blk Time (%)		
Queuing Penalty (veh)		
Storage Bay Dist (ft)		
Storage Blk Time (%)		
Queuing Penalty (veh)		

Intersection: 5: Rhododendron & 35th st, All Intervals

Movement	WB	NB	SB
Directions Served	LR	TR	LT
Maximum Queue (ft)	94	4	78
Average Queue (ft)	45	0	17
95th Queue (ft)	77	3	56
Link Distance (ft)	880	444	1300
Upstream Blk Time (%)			
Queuing Penalty (veh)			
Storage Bay Dist (ft)			
Storage Blk Time (%)			
Queuing Penalty (veh)			

Network Summary

Network wide Queuing Penalty, Interval #0: 0
Network wide Queuing Penalty, Interval #1: 0
Network wide Queuing Penalty, Interval #2: 0
Network wide Queuing Penalty, All Intervals: 0

Intersection: 3: Rhododendron & tournament, Interval #0

Movement	WB
Directions Served	LR
Maximum Queue (ft)	63
Average Queue (ft)	44
95th Queue (ft)	79
Link Distance (ft)	694
Upstream Blk Time (%)	
Queuing Penalty (veh)	
Storage Bay Dist (ft)	
Storage Blk Time (%)	
Queuing Penalty (veh)	

Intersection: 3: Rhododendron & tournament, Interval #1

Movement	WB	SB
Directions Served	LR	LT
Maximum Queue (ft)	60	6
Average Queue (ft)	33	0
95th Queue (ft)	65	0
Link Distance (ft)	694	612
Upstream Blk Time (%)		
Queuing Penalty (veh)		
Storage Bay Dist (ft)		
Storage Blk Time (%)		
Queuing Penalty (veh)		

Intersection: 3: Rhododendron & tournament, Interval #2

Movement	WB	SB
Directions Served	LR	LT
Maximum Queue (ft)	56	6
Average Queue (ft)	28	0
95th Queue (ft)	57	5
Link Distance (ft)	694	612
Upstream Blk Time (%)		
Queuing Penalty (veh)		
Storage Bay Dist (ft)		
Storage Blk Time (%)		
Queuing Penalty (veh)		

Intersection: 3: Rhododendron & tournament, All Intervals

Movement	WB	SB
Directions Served	LR	LT
Maximum Queue (ft)	71	12
Average Queue (ft)	31	0
95th Queue (ft)	63	4
Link Distance (ft)	694	612
Upstream Blk Time (%)		
Queuing Penalty (veh)		
Storage Bay Dist (ft)		
Storage Blk Time (%)		
Queuing Penalty (veh)		

Intersection: 5: Rhododendron & 35th st, Interval #0

Movement	WB	SB
Directions Served	LR	LT
Maximum Queue (ft)	135	92
Average Queue (ft)	74	46
95th Queue (ft)	145	112
Link Distance (ft)	880	1300
Upstream Blk Time (%)		
Queuing Penalty (veh)		
Storage Bay Dist (ft)		
Storage Blk Time (%)		
Queuing Penalty (veh)		

Intersection: 5: Rhododendron & 35th st, Interval #1

Movement	WB	SB
Directions Served	LR	LT
Maximum Queue (ft)	96	77
Average Queue (ft)	60	34
95th Queue (ft)	95	76
Link Distance (ft)	880	1300
Upstream Blk Time (%)		
Queuing Penalty (veh)		
Storage Bay Dist (ft)		
Storage Blk Time (%)		
Queuing Penalty (veh)		

Intersection: 5: Rhododendron & 35th st, Interval #2

Movement	WB	NB	SB
Directions Served	LR	TR	LT
Maximum Queue (ft)	84	4	96
Average Queue (ft)	50	0	31
95th Queue (ft)	78	4	77
Link Distance (ft)	880	444	1300
Upstream Blk Time (%)			
Queuing Penalty (veh)			
Storage Bay Dist (ft)			
Storage Blk Time (%)			
Queuing Penalty (veh)			

Intersection: 5: Rhododendron & 35th st, All Intervals

Movement	WB	NB	SB
Directions Served	LR	TR	LT
Maximum Queue (ft)	137	4	111
Average Queue (ft)	56	0	34
95th Queue (ft)	97	3	83
Link Distance (ft)	880	444	1300
Upstream Blk Time (%)			
Queuing Penalty (veh)			
Storage Bay Dist (ft)			
Storage Blk Time (%)			
Queuing Penalty (veh)			

Network Summary

Network wide Queuing Penalty, Interval #0: 0
Network wide Queuing Penalty, Interval #1: 0
Network wide Queuing Penalty, Interval #2: 0
Network wide Queuing Penalty, All Intervals: 0

SANDOW ENGINEERING

160 Madison Street, Suite A
Eugene, Oregon 97402
541.513.3376
sandowengineering.com



**CITY OF FLORENCE
PHASE I SITE INVESTIGATION REPORT**

Joseph M. Pearson, Pacific Gold Communities LLC
Applicant

9/22/2022
Date

Fairway Estates Phase II PUD/Subdivision Application
PC 21 39 SUB 03 & PC 21 40 PUD 02
Proposal or Project

18-12-15-00, TL 1500
Map No. Tax Lot

Subdivision and PUD
Purpose of Proposal or Project (attach additional sheets, as needed)

Open Space Private
Comprehensive Plan Designation

(unknown)
Street Address

R2 zoning district
Zoning District

(unknown)
Overlay District

Based on submitted information, zoning and comprehensive plan requirements, and the completed Site Investigation Report, this proposal **does / does not** comply with Title 10 of the City Code and the Comprehensive Plan. The proposal **will / will not** achieve the stated purpose. The site and/or building design **will / will not** have adverse impacts and **will / will not** mitigate any adverse impacts.

The completed Site Investigation Report is available at the Planning Department.

This investigation was done by:

Print

Signature

Title

**PHASE I SITE INVESTIGATION
INITIAL PROPOSED DEVELOPMENT APPLICATION CHECKLIST**

- | YES | NO | |
|-------|-------|---|
| _____ | _____ | 1. <u>LOCAL ZONING REGULATIONS</u>
Does the proposed development site plan conform to City, or County Zoning Regulations regarding setback lines and other code provisions? (Contact the City or County Engineer for details.) |
| _____ | _____ | 2. <u>COMPREHENSIVE PLAN SETBACK LINE OR DESIGNATION</u> |
| _____ | _____ | a. Has a Coastal Construction Setback line (CCSBL) been adopted for this County or city? (Inquire from the County or City Engineer.) |
| _____ | _____ | b. If a CCSBL has been adopted for this County or City is the proposed site seaward of the CCSBL? |
| _____ | _____ | c. If the proposed site is seaward of the adopted CCSBL, has application for a variance or exception been made to the Planning Commission having jurisdiction? |

**PHASE 1 SITE INVESTIGATION
INITIAL PROPOSED DEVELOPMENT APPLICATION CHECKLIST**

YES NO

3. DUNAL FORMS

- | | | |
|-------|-------|--|
| _____ | _____ | a. Does the property contain any of the following dune formations? |
| _____ | _____ | 1. Active Dune |
| _____ | _____ | 2. Newer Stabilized Dune |
| _____ | _____ | 3. Older Stabilized Dune |
| _____ | _____ | 4. Deflation Plan |
| _____ | _____ | 5. leading Edge of Sand dune |
| _____ | _____ | 6. Foredune |

3. IDENTIFIED HAZARDOUS CONDITIONS

- | | | |
|-------|-------|---|
| _____ | _____ | a. Has any portion of the property been identified as being affected by any potential or existing geological hazard? (Contact County or City Planning Departments for information published by the State Department of Geology and Mineral Industries, US Department of Agriculture-Soil Conservation Service, US Geological Survey, US Army Corps of Engineers and other government agencies.) |
| _____ | _____ | b. Are any of the following identified hazards present? |
| _____ | _____ | 1. foredune |
| _____ | _____ | 2. Active Dunes |
| _____ | _____ | 3. Water erosion |
| _____ | _____ | 4. Flooding |
| _____ | _____ | 5. Wind erosion |
| _____ | _____ | 6. Landslide or sluff activity |
| _____ | _____ | 7. leading edge of active Sand Dune |
| | | c. Are there records of these hazards ever being present of the site? Describe: |

4. EXISTING SITE VEGETATION

- | | | |
|-------|-------|--|
| _____ | _____ | a. Does the vegetation on the site, afford adequate protection against soil erosion from wind and surface water runoff? |
| _____ | _____ | b. Does the condition of vegetation present constitute a possible fire hazard or contributing factor to slide potential? |
| | | (If answer is Yes, full details and possible remedies will be required.) |

5. FISH AND WILDLIFE HABITAT

- | | | |
|-------|-------|---|
| _____ | _____ | a. Does the site contain any identified rare or endangered species or unique habitat (feeding, nesting or resting)? |
| _____ | _____ | b. Will any significant habitat be adversely affected by the development? (Contact Oregon Department of Fish and Wildlife.) |

6. HISTORICAL AND ARCHEELOGICAL SITES

- | | | |
|-------|-------|--|
| _____ | _____ | Are there any identified historical or archaeological sites within the area proposed for development? (Confederated Tribes of the Coos, Lower Umpqua and Siuslaw Indians.) |
|-------|-------|--|

7. FLOOD PLAIN ELEVATION

- | | | |
|-------|-------|---|
| _____ | _____ | a. If the elevation of the 100 year flood plain or storm tide has been determined, does it exceed the existing ground elevation at the proposed building site? (Contact the Federal Insurance Administration, City or County Planning |
|-------|-------|---|

**PHASE 1 SITE INVESTIGATION
INITIAL PROPOSED DEVELOPMENT APPLICATION CHECKLIST**

YES NO

Departments for information on 100 year flood plain. Existing site elevations can be identified by local registered surveyor.)

_____ _____ b. If elevations of the proposed development is subject to flooding during the 100 year flood or storm tide, will the lowest habitable floor be raised above the top of the highest predicted storm-wave cresting on the 100 year flood or storm tide?

8. CONDITION OF ADJOINING AND NEARBY AREAS

Are any of the following natural hazards present on the adjoining or nearby properties that would pose a threat to this site?

- _____ _____ a. Active dunes
_____ _____ b. foredune
_____ _____ c. Storm runoff erosion
_____ _____ d. Wave undercutting or wave overtopping
_____ _____ e. Slide areas
_____ _____ f. Combustible vegetative cover
(Contact County and City Planning staffs for local hazard information.)

9. DEVELOPMENT IMPACTS

- _____ _____ a. Will there be adverse off-site impacts as a result of this development?
_____ _____ b. Identify possible problem type
_____ _____ 1. Increased wind exposure
_____ _____ 2. Open sand movement
_____ _____ 3. Vegetative destruction
_____ _____ 4. Increased water erosion (storm runoff, driftwood removal, reduction of foredune, etc.)
_____ _____ 5. Increased slide potential
_____ _____ 6. Affect on aquifer
_____ _____ c. Has landform capability (density, slope failure, groundwater, vegetation, etc) been a consideration in preparing the development proposal?
_____ _____ d. Will there be social and economic benefits from the proposed development?
_____ _____ e. Identified benefits
_____ _____ 1. New jobs
_____ _____ 2. Increased tax valuation
_____ _____ 3. Improved fish and wildlife habitat
_____ _____ 4. Public access
_____ _____ 5. Housing needs
_____ _____ 6. Recreation potential
_____ _____ 7. Dune stabilization (protection of other features)
_____ _____ 8. Other _____

10. PROPOSED DESIGN

- _____ _____ a. Has a site map been submitted showing in detail exact location of proposed structures?
_____ _____ b. Have detailed plans showing structure foundations been submitted?
_____ _____ c. Have detailed plans and specifications for the placement of protective structures been submitted if need is indicated?
_____ _____ d. Has a plan for interim stabilization, permanent revegetation and continuing vegetative maintenance been submitted?
_____ _____ e. Is the area currently being used by the following?

**PHASE 1 SITE INVESTIGATION
INITIAL PROPOSED DEVELOPMENT APPLICATION CHECKLIST**

YES NO

____ ____
____ ____
____ ____
____ ____

- 1. Off-road vehicles
- 2. motorcycles
- 3. horses
- f. Has a plan been developed to control or prohibit the uses of off-road vehicles, motorcycles and horses?

11. LCDC COASTAL GOAL REQUIREMENTS

____ ____
____ ____
____ ____
____ ____

- a. Have you read the LCDC Goals affecting the site? (contact LCDC, City or County office for copies of Goals.)
- b. Have you identified any possible conflicts between the proposed development and the Goals or acknowledged comprehensive plans? (If so, list them and contact local planning staff for possible resolution.)
- c. Have all federal and state agency consistency requirements been met? (Contact local planning office.)
- d. Has applicant or investigator determined that the development proposal is compatible with the LCDD Beaches and Dunes Goal and other appropriate statewide land use planning laws?

Rev. 4/09